

Ikegami

MODEL

HLM-960WR

HLM-1760WR

HLM-2460W

FULL HD MULTI FORMAT
LCD COLOR MONITOR

OPERATION MANUAL

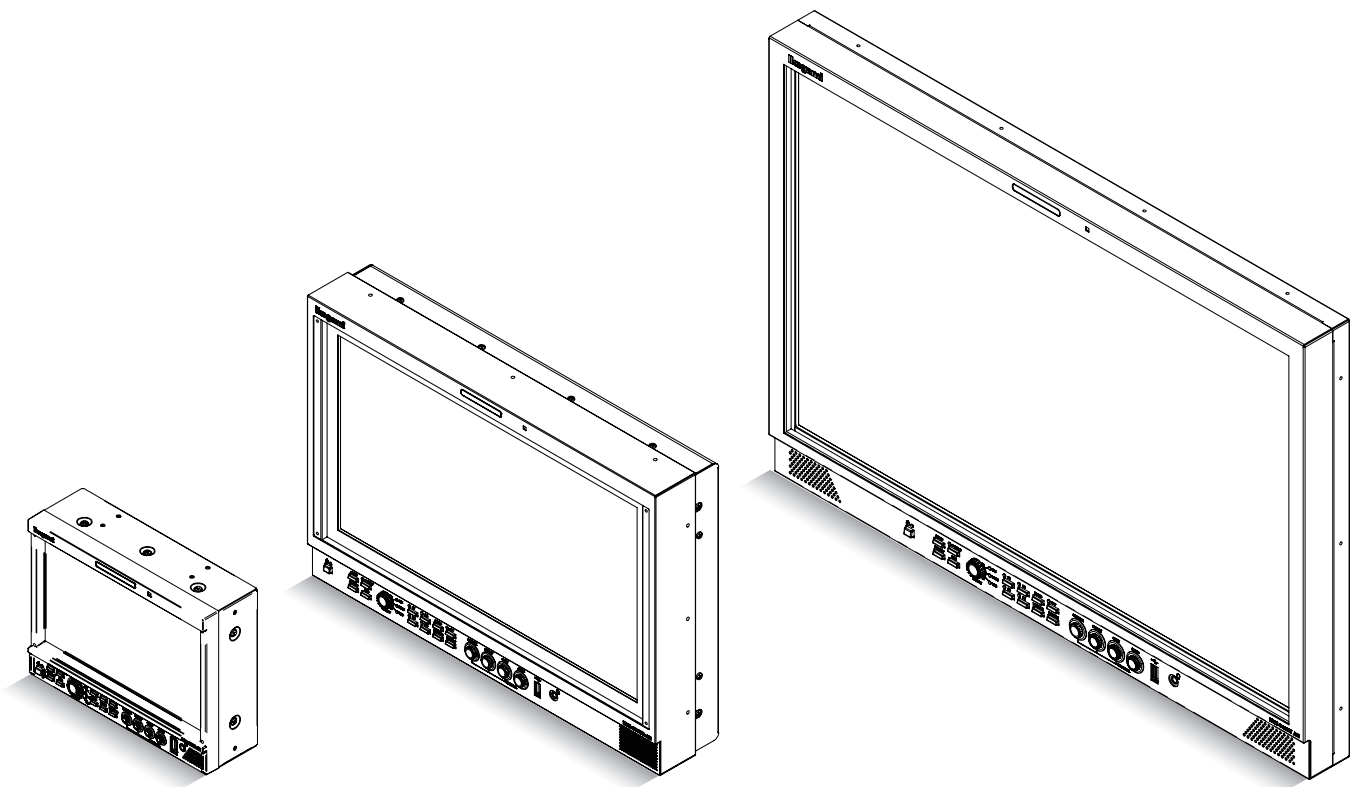

HD

HDMI

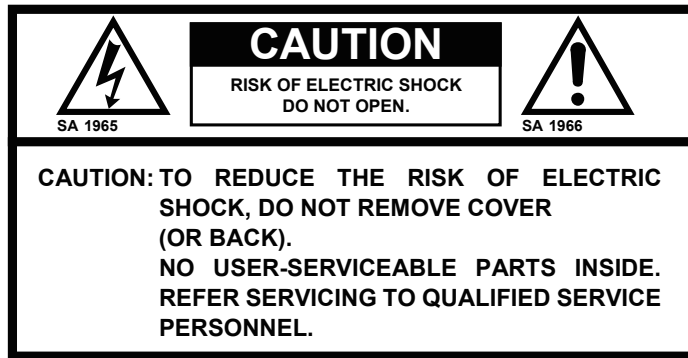

The lightning flash with arrowhead inside a triangle is intended to warn the user that parts inside the product are dangerous and many cause electric hazards.



The exclamation mark inside a triangle is intended to inform users that important operating and servicing instructions are provided with the equipment.

WARNING: FOR CONTINUED SAFETY, REPLACE SAFETY CRITICAL COMPONENTS ONLY WITH MANUFACTURE’S RECOMMENDED PARTS (REFER TO SERVICE LITERATURE).

DECLARATION of CONFORMITY :

The “CE” mark means the products as mentioned below will meet the intent of the following Directives and Standards.

- Directives** : 2014/30/EU for EMC (electromagnetic compatibility)
 2014/35/EU for Low voltage (Safety)
 2011/65/EU for RoHS directive

- Standards** : HLM-960WR, HLM-1760WR, HLM-2460W: EN55032 (Class A), EN55103-2-E4, EN60950-1

WARNING: TO REDUCE THE RISK OF ELECTRIC SHOCK, DO NOT EXPOSE THIS EQUIPMENT TO RAIN OR WATER.



**Disposal of used Electric and Electronic Equipment
 (Applicable in the European Union and other European countries with separate collection systems)**

This symbol on the product, or in the related documents in the package, indicates that this product shall not be treated as normal household waste. Instead, it should be taken to a proper applicable collection point or depot for the recycling of electric and electronic equipment.

By ensuring this product is disposed of correctly, you will help prevent possible negative consequences for the environment and human health, which could otherwise be caused by inappropriate waste handling of this product. The recycling of materials will help to conserve natural resources.

For more detailed information about recycling of this product, please contact your local city authority, your household waste disposal service or the place where you purchased the product.

NOTE:

This equipment has been tested and found to comply with the limits for a Class A digital device, pursuant to Part 15 of the FCC Rules. These limits are designed to provide reasonable protection against harmful interference when the equipment is operated in a commercial environment. This equipment generates, uses and can radiate radio frequency energy and, if not installed and used in accordance with the instruction manual, may cause harmful interference to radio communications.

Operation of this equipment in a residential area is likely to cause harmful interference in which case the user will be required to correct the interference at his own expense.

CAUTION;

ANY CHANGES OR MODIFICATIONS NOT EXPRESSLY APPROVED BY THE PART RESPONSIBLE FOR COMPLIANCE COULD VOID THE USERS AUTHORITY TO OPERATE THE EQUIPMENT.

IMPORTANT SAFETY INSTRUCTIONS

1. General

- 1) Read all instructions provided.
- 2) Save these instructions for future use.
- 3) Follow all warnings and instructions marked on the television equipment.
- 4) Never insert objects of any kind into this television monitor through cabinet slots as they may come in contact with dangerous voltage points or short out parts, resulting in fire or electric hazards, never spill liquid of any kind on the television monitor.
- 5) Do not attempt to service this television monitor yourself as operating or removing covers may expose you to dangerous voltage or other hazards, Refer all servicing to qualified service personnel.
- 6) Do not use attachments not recommended by the television equipment manufacturer as they may result in the risk of fire, electric shock, or injury to persons.
- 7) This television monitor has been preadjusted to meet the respective broadcasting standard signals. So, it cannot be used with the signals of different broadcasting standards.
- 8) When keeping or transporting the unit for a long time, pack it in the supplied carton or equivalent.

2. Power supply

- 1) This television equipment should be operated only from the type of power source indicated on the marking label.
- 2) This television equipment is provided with a three-wire grounding type plug with a third (grounding) pin. This plug will only fit into a grounding-type power outlet. This is a safety feature. If you are unable to insert the plug into the outlet, contact your electrician to replace your obsolete outlet.
Do not defeat the safety purpose of the grounding-type plug.
- 3) When connecting and disconnecting the power cable, be sure to hold the plug.
- 4) Do not allow anything to rest on the power cord. Do not place this television equipment where the cord will be abused by persons walking on it.

- 5) For added protection for this television equipment during a lightning storm, or when it is left unattended and unused for long periods of time, unplug it from the wall outlet.
This will prevent damage to the equipment due to lightning and power-line surges.
- 6) Do not overload wall outlets and extension cords as this can result in fire or electric shock.

3. Usage and location

- 1) Do not use this television equipment near water - for example, near a bath tub, kitchen sink, or laundry tub, in a wet basement, or near a swimming pool, or the like.
- 2) Do not place this television equipment on an unstable cart, stand, or table. The television equipment may fall, causing serious injury to children and adults, and serious damage to the equipment. Use only with a cart or stand recommended by the manufacture, or sold with the television equipment. Wall or shelf mounting should follow the manufacture's instructions, and should use a mounting kit approved by the manufacture.

Television equipment and cart combination should be moved with care. Quick stops, excessive force, and uneven surfaces may cause the equipment and cart combination to overturn.



- 3) Slots and openings in the cabinet and the back or bottom are provided for ventilation, and to ensure reliable operation of the monitor and to protect it from overheating, these openings should never be blocked or covered. The openings should never be blocked by placing the television equipment on a bed, sofa, rug, or other similar surface. (This television equipment should never be placed near or over a radiator or heat register.) This television equipment monitor should not be placed in a built-in installation such as a bookcase unless proper ventilation is provided.

IMPORTANT SAFETY INSTRUCTIONS

- 4) Avoid operating or placing (keeping) in a hot (+40°C or over) or cold (less than 0°C), high vibration, or dusty place. Avoid operating or storing in a place exposed to direct sunlight.
- 5) If an image of extremely high brightness is displayed on the screen for a long time, the image may get burned in.
- 3) Upon completion of any service or repairs to this monitor, ask the service technician to perform routine safety checks to determine that the television is in safe operating condition.
- 4) For repair service, contact **Ikegami's** authorized sales representative or **Ikegami** service desk directly.

4. Cleaning

- 1) Unplug this television equipment from the wall outlet before cleaning. Do not use liquid cleaners or aerosol cleaners. Use a damp cloth for cleaning.
- 2) Do not use thinner or benzene for cleaning. Otherwise, the cabinet may deform or the paint may peel away.

5. Repair

- 1) Unplug this television monitor from the wall outlet and refer servicing to qualified service personnel under the following conditions:
 - a. When the power cord or plug is damaged or frayed.
 - b. If liquid has been spilled into the television.
 - c. If the television monitor has been exposed to rain or water.
 - d. If the television does not operate normally by following the operating instructions.

Adjust only those controls that are covered by the operating instructions as improper adjustment of other controls may result in damage and will often require extensive work by a qualified technician to restore the television monitor to normal operation.
 - e. If the television monitor has been dropped or the cabinet has been damaged.
 - f. When the monitor exhibits a distinct change in performance - this indicates a need for service.
- 2) When replacement parts are required, be sure the service technician has used replacement parts specified by the manufacture that have the same characteristics as the original part.

Unauthorized substitutions may result in fire, electric shock, or injury to persons.

PRECAUTIONS FOR OPERATIONS

- 1) Never let this unit fall or subject it to strong shock.
- 2) Do not remove the cabinet unless necessary.
High-voltage parts are contained in the cabinet and they are very dangerous if you touch them. Only qualified service engineers are allowed to adjust the internal parts of the cabinet.
- 3) This color monitor has been adjusted to signals conforming to each broadcasting standard. It cannot be used for signals of different broadcasting standards.
Be sure to operate the color monitor within the voltage range marked on its back.
- 4) If cabinet or screen is dirty, wipe with soft cloth. At this time, avoid using benzene or thinner, otherwise the paint may peel away.
- 5) Note that, if video signals with high luminance are monitored on the LCD panel over a long period of time, the image may get burned into the panel.
- 6) The socket-outlet shall be installed near the equipment and shall be easily accessible.
- 7) Avoid using or storing this unit in the following places:
 - Hot (+40°C or more) or cold (0°C or less) places, especially where this unit may be exposed to the direct rays of the sun.
 - Humid and dusty places.
 - Places where there is considerable vibration.
 - Places exposed to rain or water.
 - When storing or transporting this unit, pack it in the supplied carton or equivalent.
- 8) If no image can be monitored even after performing user adjustment or the unit appears faulty, do not dismantle this unit by yourself. In such cases, contact the **Ikegami** service desk.
- 9) Should this unit fail within one year after delivery, it will be repaired free of charge unless the malfunction was caused by mishandling or misuse of the user.
However, the fuses are not covered by the warranty.
- 10) The specifications and appearance of this unit may be subject to change for further improvement without prior notice.

Cautions for Rack-Mount.

- 1) Elevated Operating Ambient - If installed in a closed or multi-unit rack assembly, the operating ambient temperature of the rack environment may be greater than room ambient. Therefore, consideration should be given to installing the equipment in an environment compatible with the maximum ambient temperature (T_{ma}) specified by the manufacturer.
- 2) Reduced Air Flow - Installation of the equipment in a rack should be such that the amount of air flow required for safe operation of the equipment is not compromised.
- 3) Mechanical Loading - Mounting of the equipment in the rack should be such that a hazardous condition is not achieved due to uneven mechanical loading.
- 4) Circuit Overloading - Consideration should be given to the connection of the equipment to the supply circuit and the effect that overloading of the circuits might have on overcurrent protection and supply wiring. Appropriate consideration of equipment nameplate ratings should be used when addressing this concern.
- 5) Reliable Earthing - Reliable earthing of rack-mounted equipment should be maintained. Particular attention should be given to supply connections other than direct connections to the branch circuit (e.g. use of power strips).

Precautions Upon Use

In order to use the monitor safely, read through this manual and pay attention to the following points in particular.

1. Do not use any power supply other than the specified one (AC/DC).

2. Do not give a shock to the monitor.

Be very careful to keep the monitor from shocks because glass is used inside the LCD.

3. Do not use or store the monitor in the following places.

Place where the ambient temperature is out of spec

When installing the monitor on a monitor shelf, switcher table, rack, etc., make sure in advance that the temperature of the installation location is within the specified range.

In the case of an outdoor setup, even if the ambient temperature is within the specified range, the inside of the monitor may be heated by direct sunlight. Therefore, keep radiation in mind. (Avoid direct sunlight.)

Never block the air outlet at the rear of the monitor and the air inlet at the side. Make sure in particular that a blackout curtain or the like does not block the air outlet.

Place exposed to rain, snow or high humidity

Use of the monitor in such a place will cause electric leakage or failure.

4. Please avoid direct sunlight on the screen.

Exposure of the LCD screen to direct sunlight for a long time will degrade the film. Therefore be careful of direct sunlight when using the monitor outdoors.

5. Caution for the panel surface

Be careful not to touch the LCD panel front surface with bare hands, unless necessary. When wiping the dust off the surface, use soft, dry cloth and take care not to rub the surface strongly. Do not use thinner or benzene.

6. Do not touch liquid crystal leaked from the monitor's display surface.

If the monitor's display surface is accidentally broken and the liquid crystal leaks, be careful never to put the liquid in your mouth, inhale it and allow it on your skin. If the liquid gets into your eye or mouth, immediately rinse it with water and get medical attention.

If the liquid contacts your skin or clothes, immediately wipe it off using alcohol or the like and wash the stained spot with soap and water. Do not leave the liquid intact, because otherwise your skin or clothes may be affected.

7. Caution when used for a long continuous display

If the LCD panel is used for a long continuous display of fixed bright images, still images, etc. or continuously used under hot and humid environment, after-images, lower luminance, seizure, stains, streaks, discoloration etc., may occur due to the structure of the LCD panel.

Please avoid a long continuous display of videos with especially bright still images, white displays of computer windows, videos that are smaller than the display area because of the aspect change, etc. Also avoid continuously using it in a closed room that can be hot and humid or near outlets of air conditioning equipment.

A long continuous use with such videos and environment can cause the LCD panel to age at a faster rate.

In order to prevent the aging phenomenon, we recommend to avoid a long continuous display of fixed bright images or still images and lower the brightness, as well as to turn off the power of the main unit when it is not used.

(After-images may be gradually resolved by changing the screen display.)

8. Avoid operation at low temperatures.

The response speed of the liquid crystal decreases as the temperature decreases. Therefore, it is recommended to use the monitor at room temperature.

9. Caution for condensation.

When the monitor is used in conditions where the temperature abruptly changes, the surfaces outside and inside monitor may get condensation.

And if it is used leaving condensation, it can cause deterioration of quality and trouble.

If the device has condensation, please do not turn on the power until water drops disappear completely.

10. Avoid operation or storage in a place exposed to corrosive gas.

Operation or storage in a place where any corrosive gas such as sulfur dioxide, hydrogen sulfide, chlorine or ammonia is generated may lead to a significant reduction in the monitor service life. It may also cause failure or electric leakage.

Also avoid using the monitor in a location exposed to high salty wind.

11. Do not use this monitor for critical applications such as space application, nuclear control system, or medical equipment involving human life.

12. Considerations when storing the monitor in a hard carrying case.

The LCD panel used for this monitor has a very delicate structure that is composed of multiple layers of expensive films. Therefore, the following considerations must be taken into account when storing the monitor in a hard case.

- If the monitor that has been stored at low temperature for a long time is suddenly exposed to high temperature environment, dew condensation may occur. When you store the monitor in the case for a long time, **make sure to store at a temperature near room temperature** and avoid a sudden temperature change when taking out the monitor from the case.
- If you are planning to store the monitor in the case for a long time, make sure to **replace silica gels, etc. in a regular basis and store the monitor at proper humidity** as the humidity in the case can cause corrosion.
- If the monitor is stored in the case with water droplets or condensation for a long time, the humidity stays in the case and can cause corrosion. **Make sure to allow the monitor to dry well before storing in the case.**

Quality of LCD panel

Note that because the LCD panel mounted on the monitor is manufactured through the use of high-precision technology, 99.99% or more of the pixels are effective, but 0.01% or less of them may be lacking in brightness or lit up constantly.

Internal fan

The internal fan does not run constantly but automatically starts running when the internal temperature of the monitor rises. When the environmental temperature is low, the internal fan may not be running, which indicates no fault condition.

At power-on, the fan rotates for a moment for checking its own performance.

In the case of outdoor use, even if the ambient temperature is low, the fan may start running when the internal temperature of the monitor rises.

Suppose that the fan does not operate properly at power-on or at high temperatures. In such

case, the message "FAN ERROR!" will appear at the top of the screen.

The brightness of the backlight may be reduced in order to keep the internal temperature of the motor from rising.

If the message "FAN ERROR!" is displayed, contact your dealer or **Ikegami** service desk.

Warranty

If the product should fail within one year from the date of delivery in spite of the proper use, the manufacturer will repair the product free of charge. Even if the product is covered by the warranty, however, the customer will be charged for labor and parts in the following cases.

1. Failure and damage caused by the following:
 - Improper use
 - Repair or modification performed by the customer
 - Transportation, transfer, falling, etc. after the purchase of the product
 - External factors such as natural disasters and over-voltage
2. LCD panel burn-in and aged deterioration (discoloration, burn-in, change in brightness, increase in bright points and flashing, etc.)
3. Scratch or dirt on the entire surface of panel, or damage, discoloration, and deterioration of the chassis
4. Replacement of the accessories and fuse

If no image comes out in spite of routine adjustment or if the product should seem to fail, contact your dealer or **Ikegami** service desk.

Accessories

The monitor comes with the following accessories. Be sure that they are included.

1. Operation manual: 1 copy
 2. Parallel remote connector: 1 set
 3. Power cable: 1 pc.
- * VGA, SVGA, XGA, SXGA, WXGA, UXGA and WUXGA are registered trademarks of International Business Machines Corporation.
 - * VESA are registered trademarks of Video Electronics Standard Association.
 - * HDMI(High Definition Multimedia Interface) and HDMI logo are registered trademarks of HDMI Licensing LLC.
 - * Specifications and external dimensions are subject to change without prior notice.

CONTENTS

IMPORTANT SAFETY INSTRUCTIONS	ii		
PRECAUTIONS FOR OPERATION	iv		
Cautions for Rack-Mount.....	iv		
Precautions Upon Use	v		
1. Outline	1	6. Mouse menu function.....	60
1-1. Outline.....	1	6-1. Basic procedure of the mouse menu	60
1-2. Features.....	1	6-2. Basic procedures on the MENU and PRESET MENU screens.....	61
2. Names of parts and their Functions	4	7. Specifications	62
2-1. Front Control Panel.....	4	7-1. General specifications.....	62
2-2. Rear panel (left).....	8	7-2. Rated performance.....	62
2-3. Rear panel (video inputs/outputs).....	9	7-3. Specifications for LCD Panel	63
2-4. External control.....	10	7-4. Functions.....	63
3. Markers.....	11	7-5. Remote control	64
3-1. Types of Markers	11	8. Mounting.....	65
4. MENU Functions	12	9. Options.....	65
4-1. MENU Outline.....	12	9-1. HLM-960WR/1760WR (Common).....	65
4-2. Description of MENU-INPUT Functions.....	13	9-2. HLM-960WR.....	65
4-3. Description of MENU-VIDEO Functions.....	16	9-3. HLM-1760WR	66
4-4. Description of MENU-AUDIO Functions	19	9-4. HLM-2460W.....	67
4-5. Description of MENU-TC/WFM/VSC Functions..	22	10. External View	68
4-6. Description of MENU-MARKER Functions	24	10-1. HLM-960WR	68
4-7. Description of MENU-MARKER Functions (USER MARKER) Functions and Setup.....	27	STD-960, STD-960T, BB-904V, BB-904A, PP-960 DR-960, HR-960, AT-900	
4-8. Description of MENU-CAPTURE Functions	31	10-2. HLM-1760WR	71
4-9. Description of MENU-UTILITY Functions.....	36	STD-1760, STD-1760T, STD-1722M, BB-1750V BB-1750A, GR-1770, PP-1760, RS-1770 RS-1770T	
4-10. Description of MENU-FUNC.SW Functions	39	10-3. HLM-2460W.....	74
4-11. Description of MENU-P.REMOTE Functions.....	41	STD-240T, GR-1770, RS-2450T	
4-12. Description of MENU-UMD/IMD Functions	42	Data 1 PC Input Signal Compatible Formats	76
4-13. Description of MENU-USB MEMORY Functions	45	Data 2 Parallel Remote Pin Functions.....	77
4-14. Description of MENU-C. CAPTION Functions....	53	Data 3 RS-485 Pin Functions	78
4-15. Description of MENU-NETWORK Functions	54	Data 4 Control with Remote Controller	79
4-16. Description of MENU-RESET Functions	55		
4-17. Description of MENU-INFO. Functions	56		
5. Preset Menu Function.....	57		
5-1. List of preset menu	57		
How to change PRESET data.....	59		

HLM-960WR / 1760WR / 2460W LCD Video Monitor

1. Outline

1-1. Outline

These monitor models have either a 9 / 17-inch full HD or 24-inch WUXGA LCD panel aiming to reduce the thickness, weight and power consumption, and are HDTV/SDTV multi-format compatible LCD color monitors, intended to be used in various locations such as a video room, edit suite, transmission control room, and field pickup van.

This monitor is compatible with the functions and operation of the HTM/TM series CRT monitors, so they can realize the functions necessary for a broadcast monitor with conventional operation.

1-2. Features

(1) High performance LCD panel

A Full HD (1920 x 1080 dots) liquid crystal panel features high brightness, high contrast, wide viewing angle, quick response and good color reproduction. Accordingly, realistic images can be displayed with high fidelity gradation, and without having to resize the input pixels.

*HLM-2460W has WUXGA (1920 x 1200 dots) liquid crystal panel.

(2) Multi-format

The monitor supports various broadcasting formats.

- 480i/59.94 (NTSC) • 1080p/24, 23.98
- 576i/50 (PAL) • 1035i/60, 59.94
- 480p/59.94 (*1) • 1080i/60, 59.94
- 576p/59.94 (*1) • 1080i/50
- 1080psF/30 • 720p/60, 59.94
- 1080psF/25 • 720p/50
- 1080psF/24, 23.98 • 720p/30, 29.97
- 1080p/60, 59.94 • 720p/24, 23.98
- 1080p/50 • 720p/25
- 1080p/30, 29.97
- 1080p/25

(*1) HDMI input only

(3) Diverse input sources

2 SDI input signals (3G/HD/SD) or 4 SDI inputs (depending on MENU setting), 1 HDMI input signal and 1 VBS input signal are included as standard.

(4) Compatibility with embedded audio

It supports embedded audio as a standard, and

automatically recognizes the embedded audio signal that is multiplexed into the SDI signal and the HDMI signal. It also enables listening to the audio output from the built-in speaker, or stereo headphone. (You can select which pair of channels to be output in the MENU.)

The monitor also has a standard embedded audio level meter display on the screen.

*HLM-2460W has the stereo speaker.

(5) Remote control functions

The monitor can be remote-controlled with the use of three remote control functions. Depending on the location of the installation and the type of operation, parallel or serial modes can be used.

Remote control with conventional parallel input interface is equipped as a standard.

The optional SRC-400 serial remote controller allows you to remote control up to 96 monitors individually by connecting the monitors with loop-through using RS485. In addition, since an Ethernet connection between the SRC-400 and a PC is possible, you can individually control the monitors that are connected to RS485 via the PC. The optional RCT-30A infrared wireless remote controller is also available.

(6) Built-in markers

4:3 (16:9 mode), 13:9, 14:9, 15:9, 16:9 (4:3 mode), 1.85:1 (16:9 mode) and 2.35:1 (16:9 mode) line markers can be displayed.

The monitor can also display a 1%-stepwise safety marker displayed in the range of 80-99% with respect to the line marker area.

The safety markers over the effective screen can be equally preset in 1% increments in the range of 80-99%.

The monitor also comes standard with five-part split and ten-part split crosshatch markers useful for location alignment.

(7) User marker display function

Up to 10 scene files of user markers can be plotted. Also up to 12 types of lines or BOX markers per 1 scene can be plotted to any given position and size on a pixel basis.

The line and box drawing settings can be easily made with not just the rotary encoder switch but also by using a USB mouse. The resulting data may also be saved on a USB memory so that the data can be copied to another monitor or stored in a PC.

This function is optimum for positioning in editing the layout and its display for various types of information such as teleshopping.

* It is patented.

(8) Shadow function

The shadow function is to shade the area other than a 4:3 (16:9 mode), 13:9, 14:9, 15:9 or 16:9 (4:3 mode) marker area on images. The shadow contrast can be set at 0%, 20%, 40% or 60% in the MENU. The use of this function allows you to instantly visualize the image area when converting images with an aspect ratio of 16:9 to those with an aspect ratio of 4:3 or vice versa.

(9) Various built-in test signals

A color bar signal, pluge signal, grayscale signal with pluge, window signal, 20% gray signal, -6.8% to 0% & 100% to 109% signals are built in as a standard test signals for the monitor, various adjustment tasks can be performed by the monitor itself.

(10) Time code display function

It is possible to display the time code (VITC/LTC) multiplexed into the 3G/HD SDI signal on the screen.

The display comes in two sizes, large and small, and its brightness can be set in three levels.

(11) Waveform monitor/Vector scope display functions

A waveform monitor of the input signal can be displayed. The display comes in two sizes, NORMAL and SMALL, and its brightness in four levels. The waveform can also be displayed in any of three selectable positions and in one of two colors: GREEN and WHITE. A vector scope can also be readily displayed.

* It corresponds to the VBS or SDI input signal.

(12) Display comparison function by using 2 split screens or by switching between 2 full screens

Two inputs can be displayed at the same time, and the display method can be selected from side by side, picture in picture, horizontal wipe, vertical wipe.

This is a convenient function to display a still picture that was captured in advance and live video that are currently being input with a split screen display, or display an image that was captured on the full screen. In addition, by manually switching or automatically switching between captured and live video, this function is

useful to adjust and align multiple cameras. Since up to 100 captured images can be controlled by number on the monitor side, you can download a desired image and use it for color matching and alignment between a captured image and camera image.

* Only signals in the same format are supported.

(13) Dot-by-dot display function

All the picture elements of an input signal are displayed 1:1 according to the pixels of the panel without scaling the incoming signal (enlarging or reducing the input signal according to the panel pixels).

This function is useful in checking input signals for pixel defects in camera CCD's and other imperfections on a pixel basis.

Only 1080i/p signal will be displayed at normal scan status of 1:1.

(14) External memory function

Various data (including the MENU settings, the PRESET data, and the full capture image data) can be stored on a USB memory for data management on a PC. All data can be copied onto another monitor.

* In case the data is to be copied onto another monitor, care should be taken as the PRESET data on individual monitors are different in their data types.

The data of the stored images is in the specific format exclusive to the monitor.

* Image data captured with an HDMI input signal can not be saved to USB memory.

(15) USB mouse control

By connecting a commercially available USB mouse to the USB terminal of this monitor, it is possible to perform various adjustments including the "MENU setting," "PRESET data setting," "Input signal switching," and the "Front switch setting" through the use of a mouse. Remote operation of the monitor at a distant position is possible by using a commercially available wireless mouse.

Use of the scroll wheel function of the mouse will significantly improved the user-friendliness of the monitor for making adjustment of various data such as color temperature.

(16) AC/DC operation

The monitor can accept AC or DC power as standard. Use of a battery is optionally possible.

The monitor allows monitoring of full HD images outdoors by use of its 9-inch or 17-inch type

10-bit full HD LCD panel.

*HLM-2460W can accept AC power only.

(17) Downmix function

Among the embedded audio 8 channels, 5.1 channel surround audio channel (Lm, Rm, C, Ls, and Rs) has been selected for the stereophonic audio function at the downmix mixing ratio specified by ARIB and ISO/IEC.

You can output the downmixed audio to the speaker that is built into the monitor or to a headphone.

(18) 2x/4x zoom function

This function enlarges the input signal 2x and 4x without scaling, and allows you to check the fine details of the image.

* The supported formats are 720p, 1080i, and 1080p.

(19) Image & TEST signal MIX function

While the image is displayed, a "pluge signal of -2%/0%/+2%" can be displayed at the same time in the corner of the screen (small enough not to disturb the image) so that you can check if there is no "black sun" effect caused by the brightness adjustment while looking at the image.

The "brightness signal of 100 to 109%" is also displayed at the same time so that you can check if the signal of 100% to 109% is not saturated when it is input during the contrast adjustment.

(20) White balance adjustment assist function

When adjusting white balance, each switch on the front can be assigned for direct white balance adjustment, which allows you to adjust the white balance quickly and easily.

* Only for HLM-1760WR and HLM-2460W.

(21) UMD/IMD display with TSL protocol

This function is used to integrally control the UMD/IMD display using "TSL UMD protocol V3.1".

Characters (alphanumeric) and TALLY can be displayed.

Up to 32 devices can be integrally controlled per one line using RS485.

By increasing the number of lines, you can set the IDs and perform individual control for up to 96 devices.

IMD : In Monitor Display

UMD : Under Monitor Display

(22) UMD/IMD display with user display

Sets a material name (alphanumeric) with up to 8 characters to individual monitor for each input (SDI-A/SDI-B/SDI-C/SDI-D/HDMI/VBS) and displays the preset material name with the UMD/IMD display when the input channel is switched.

When split screen display (Side by Side) is used, the character display can be displayed on each screen.

2. Names of parts and their Functions

2-1. Front Control Panel

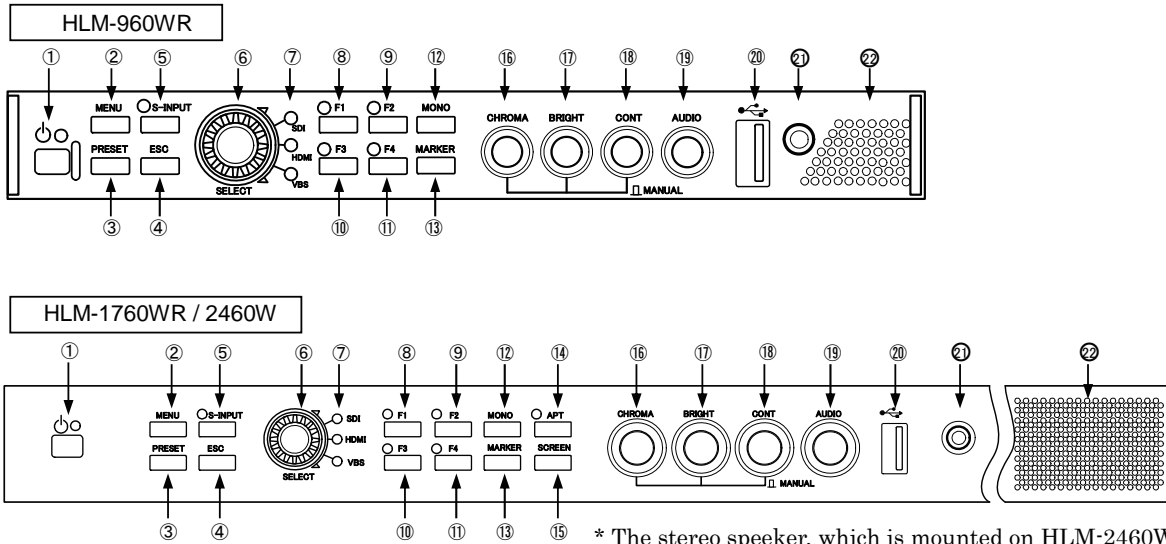

* The stereo speaker, which is mounted on HLM-2460W, is not drawn in the above illustration.

① **POWER** switch

- This switch is used to turn ON/OFF the monitor.
- * This switch will not fully turn OFF the AC power supply for the monitor.
- * It takes several seconds for an image to come up after power-on.

POWER LED

- This LED is lit up in green when the power supply for the monitor is ON.
- When running on battery, this LED indicator starts flickering to tell you the remaining battery power has become low. In such case, turn off the power and replace the battery with a new one. When the remaining battery power gets to the lower limit, the LED indicator starts flickering at quicker interval for 30 sec., then the monitor will shut down.
- When using a battery, set the nominal voltage in the menu appropriately in accordance with the type of battery to be used.

② **MENU** switch

- This switch is pressed to display the menu screen and to change the menu screen.
- MENU display is also possible by long press of the rotary encoder, item ⑥.
- * This switch is disabled when the preset menu is displayed.

③ **PRESET** switch

- This switch is pressed to display the preset menu.
- * This switch is disabled when the menu is displayed.

④ **ESC** switch

- This switch is pressed to escape from menu operation.

⑤ **S-INPUT** switch

- When the input signal SDI - B / C / D is selected, the LED will light up.
- This switch is pressed to change the input signals in the following order.
- CH-A is displayed while TEST signals are displayed (if MENU is not displayed).

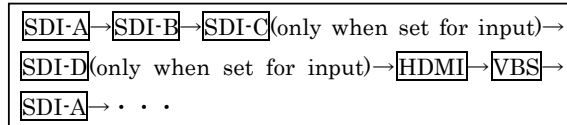

If "oENABLE" is set to "xDISABLE" in "MENU-INPUT-SOURCE SELECT" as shown below, only input signals set to "oENABLE" are selected.

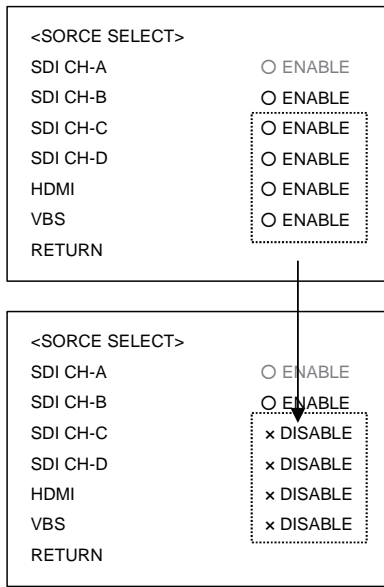

※SDI CH-A is fixed "ENABLE".

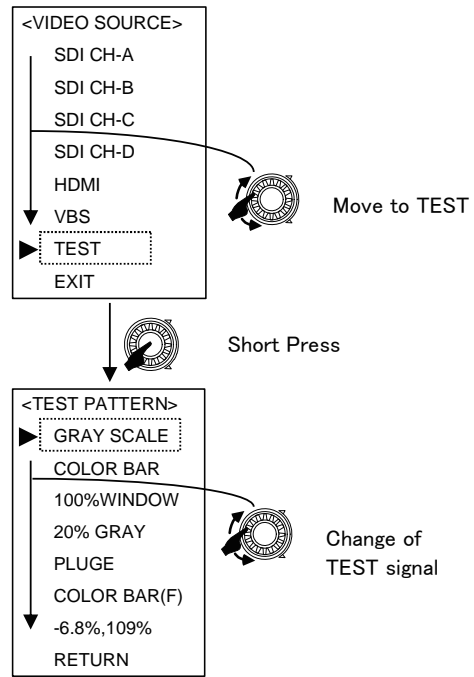

⑥ Rotally Encoder (RE)

a) Push

• **Switching the input signals**

Short press **RE** when the MENU display is OFF, to display the switch menu for input signals. Select the input signals from the menu, and press **RE** to switch the input signals.

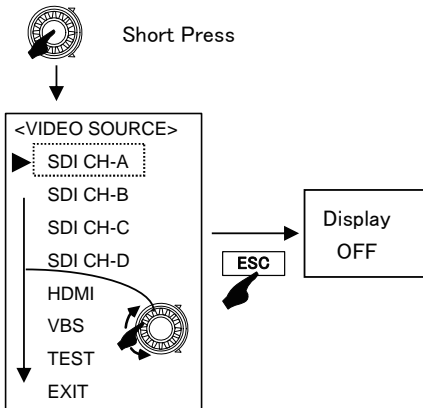

Set the inputs not necessary for "MENU-INPUT-SOURCE SELECT" described above to "×DISABLE". Then, only inputs set to "○ENABLE" can be selected.

• **Switching the TEST signals**

If "TEST" is selected here, MENU is displayed for selecting the TEST signals. So, select the TEST signal from the MENU.

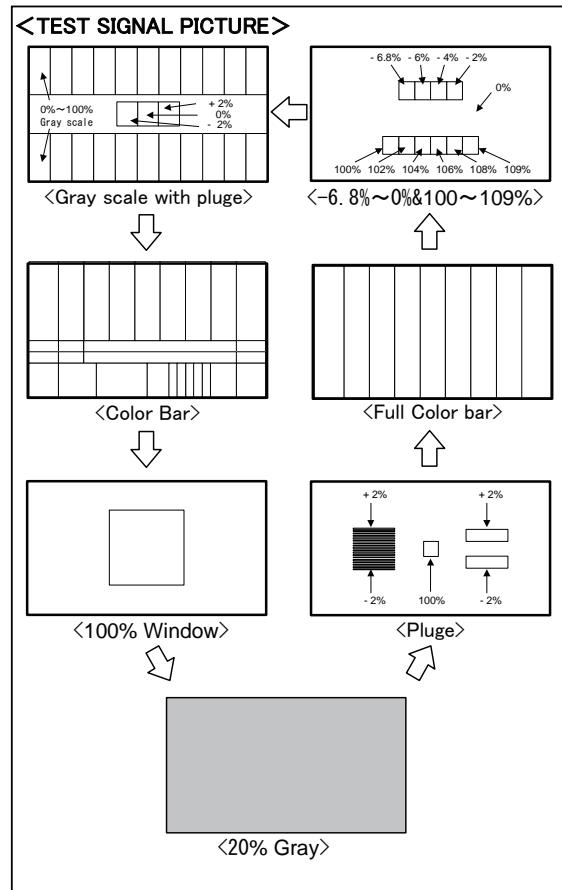

• **MENU operation**

Push the switch while MENU is displayed to select each MENU item and perform its function.

b) Long Press

- If the MENU display is OFF, a long press of the **RE** switch displays the MENU. If the MENU is displayed, a long press of the **RE** switch registers the settings and turns off the MENU display.

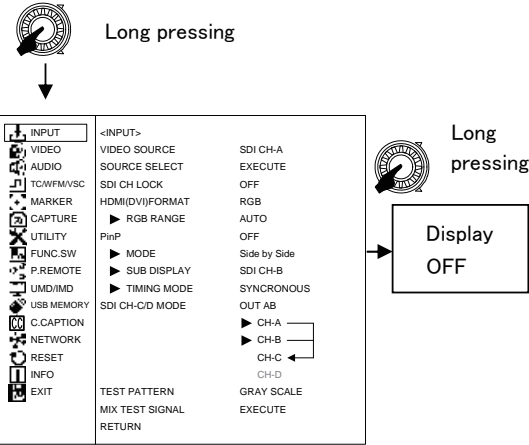

c) Rotating

- Rotate the **RE** switch while the MENU is displayed to select items.
- This switch is also used for drawing USER MARKERS, setting the WIPE area, and varying data.

⑦ INPUT LED

- These LEDs turn on to indicate the input signal that currently selected.
- All LEDs turn off when a TEST signal is displayed.

⑧ F1 switch

- Press this switch to select an item preset in the **MENU-FUNC.SW-FUNCTION-MODE**.
- For pre-settable items, refer to **"4-10. Description on MENU-FUNC. SW Functions"**

⑨ F2 switch

- Press this switch to select an item preset in the **MENU-FUNC.SW-FUNCTION-MODE**.
- For pre-settable items, refer to **"4-10. Description on MENU-FUNC. SW Functions"**

⑩ F3 switch

- Press this switch to select an item preset in the **MENU-FUNC.SW-FUNCTION-MODE**.
- For pre-settable items, refer to **"4-10. Description on MENU-FUNC. SW Functions"**

⑪ F4 switch

- Press this switch to select an item preset in the

MENU-FUNC.SW-FUNCTION-MODE.

- For pre-settable items, refer to **"4-10. Description on MENU-FUNC. SW Functions"**

⑫ MONO switch

- This switch is pressed to make a color signal monochrome.

⑬ MARKER switch

- Press this switch to turn on/off markers.
- * This function is disabled when an internal test signal is displayed.
- * This function does not work when a TEST signal is selected.

⑭ APT switch

- Press this switch to select the aperture function.
- Set a correction amount on **MENU-VIDEO-APERTURE-LEVEL**.
- * The frequency of the aperture in PinP is fixed at "HIGH".
- * This switch is not available for the HLM - 960WR, but it can be assigned to a FUNCTION switch.

⑮ SCREEN switch

- Press this switch to display images in R, G or B individually.
- The switching between colors takes place as follows each time this switch is pressed.
"R only" → "G only" → "B only" → "Normal Screen"
- * This switch is not available for the HLM - 960WR, but it can be assigned to a FUNCTION switch.

⑯ CHROMA manual control

- This control serves as a manual/preset switch for chroma or a manual data variable control.
- The control pops out when it is pressed and the mode is changed to MANUAL.

⑰ BRIGHT manual control

- This control serves as a manual/preset switch for brightness or a manual data variable control.
- The control pops out when it is pressed and the mode is changed to MANUAL.

⑱ CONT manual control

- This control serves as a manual/preset switch for contrast or a manual data variable control.
- The control pops out when it is pressed and the mode is changed to MANUAL.
- This control can be an allocation to BACK-LIGHT according to the **MENU-UTILITY-CONT**

VR ASSIGN setting.

⑱ **AUDIO** control

- Use this control to adjust the sound volume of the front speaker or the headphones.
- * An audio (analog/embedded audio) to be outputted to the speaker must be set on **MENU-AUDIO-SP INPUT SEL.**
- * If you input an audio signal of -10 dBFS or more with embedded audio, distortion will occur even if you lower the audio volume.
Especially in continuous sound of -10 dBFS or more, the sound has distortion.
- * Distortion may occur when the audio volume is used at max.

⑳ **USB** terminal

- Connect a USB memory, and the monitor's data can be saved on the USB memory or the data on the USB memory can be downloaded to another monitor.
- It is possible some memory devices do not work in the USB memory slot of the monitor, please try another memory in that case.
- Connect a USB mouse, and the user markers can be drawn.

㉑ **Stereo headphones output** (stereo mini-jack type)

- Analog audio signals, embedded audio signals and downmix audio signals are fed out of this terminal.
- The analog and embedded inputs can be selected in **MENU-AUDIO-SP INPUT SEL.**
- * If you are using a sound isolating headphone, some residual sound may be heard even when the sound volume is set to minimus.

㉒ **Speakers**

- Analog audio signals, embedded audio signals and downmix audio signals are fed to the speakers.
- The analog and embedded inputs can be selected in **MENU-AUDIO-SP INPUT SEL.**
- With the headphones being connected, no sound is heard from the speakers.

2-2. Rear panel (left) (HLM-2460W has no DC input.)

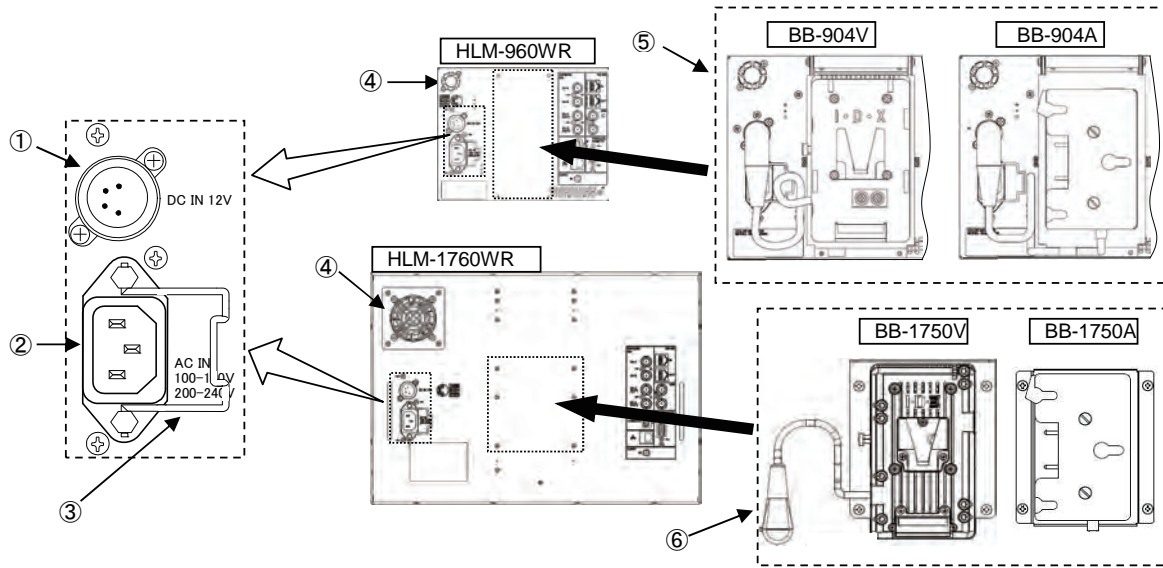

① DC input

- Insert a DC cable here to supply DC +12V power.

② AC power input

- Insert an AC cable here to supply AC power.

③ Lock

- After inserting an AC plug, lock the AC plug with this lock to prevent it from disconnecting.

④ Fan

- When power is turned on, the fan starts running for the operational check. Then, it automatically operates according to the internal temperature.
- If the fan does not start running, the message "FAN ERROR!" is displayed on the screen.

⑤ BB-904A/V (for HLM-960WR)

- Insert a BB-904A (ANTON BAUER battery) here to supply battery power.
- Insert a BB-904V (V type battery) here to supply IDX battery power.

⑥ BB-1750A/V (for HLM-1760WR)

- Insert a BB-1750A (ANTON BAUER battery) here to supply battery power.
- Insert a BB-1750V (V type battery) here to supply IDX battery power.

◆PRECAUTIONS

- When using an external DC power supply, be sure to check the rating of the external DC power supply, and use one that is compatible with this monitor.
- Check the pin arrangement of the DC output terminal of the external DC power supply and the DC IN terminal of this unit, and connect polarity correctly.
- Incorrectly connecting a + 12V power supply to the GND terminal may cause a fire or injury.

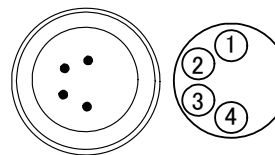

Pin No.	Signal
1	GND
2, 3	—
4	+12V

- Connect the power cord included with this unit to a 3-pin outlet with ground terminal.

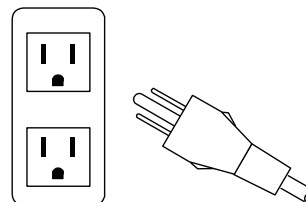

2-3. Rear panel (video inputs/outputs)

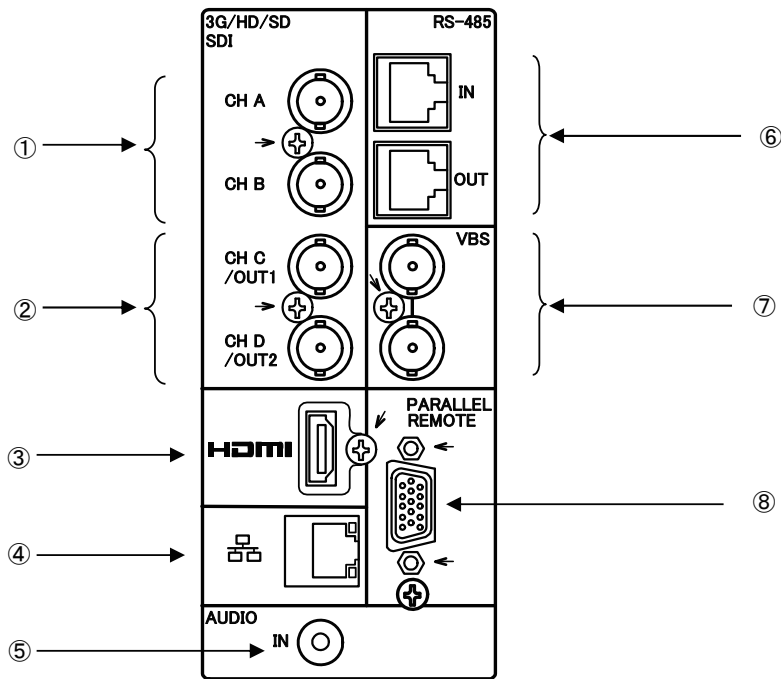

① SDI A/B signal input

- Input a 3G/HD-SDI or SD-SDI (4:2:2) signal here.
- The format of input signal is automatically identified.

② SDI C(OUT1)/D(OUT2) signal input and output

- Both input and output can be set in the "MENU-INPUT-SDI CH-C/D MODE" settings, and 10 different combinations are possible.
- Input 3G/HD/SD-SDI(4:2:2) signals to this connector.
- Input signal format is automatically identified.
- Please refer to "4-2. Function Description of MENU-INPUT" for the input/output setting items.

③ HDMI signal input

- Input an HDMI signal (HDCP compatible) here.

④ Ethernet

⑤ Analog audio input

- Feed analog stereo audio signal here.

⑥ RS-485 connection

- Monitor control is possible by connecting a serial remote controller "SRC - 400" here.
- It is possible to control "TSL UMD Protocol V3.1".
- If it is not a loop-through connection, use a terminator.
- Set the monitor ID number within the range from 000 to 126 in "MENU-UMD/IMD-TSL MONITOR ID".
- Please refer to "4-12. Function Description of MENU-UMD/IMD" for the setting items.

⑦ NTSC/PAL analog composite input

- Input an NTSC/PAL analog composite (VBS) signal here.
- Without the loop through connection in place, connect a terminating plug.

⑧ PARALLEL REMOTE signal input

- Connect the accompanying remote connector here.
- Use shielded wire for the cable.
- For the setting items, refer to "4-11. Function explanation of MENU - P.REMOTE".

2-4. External control

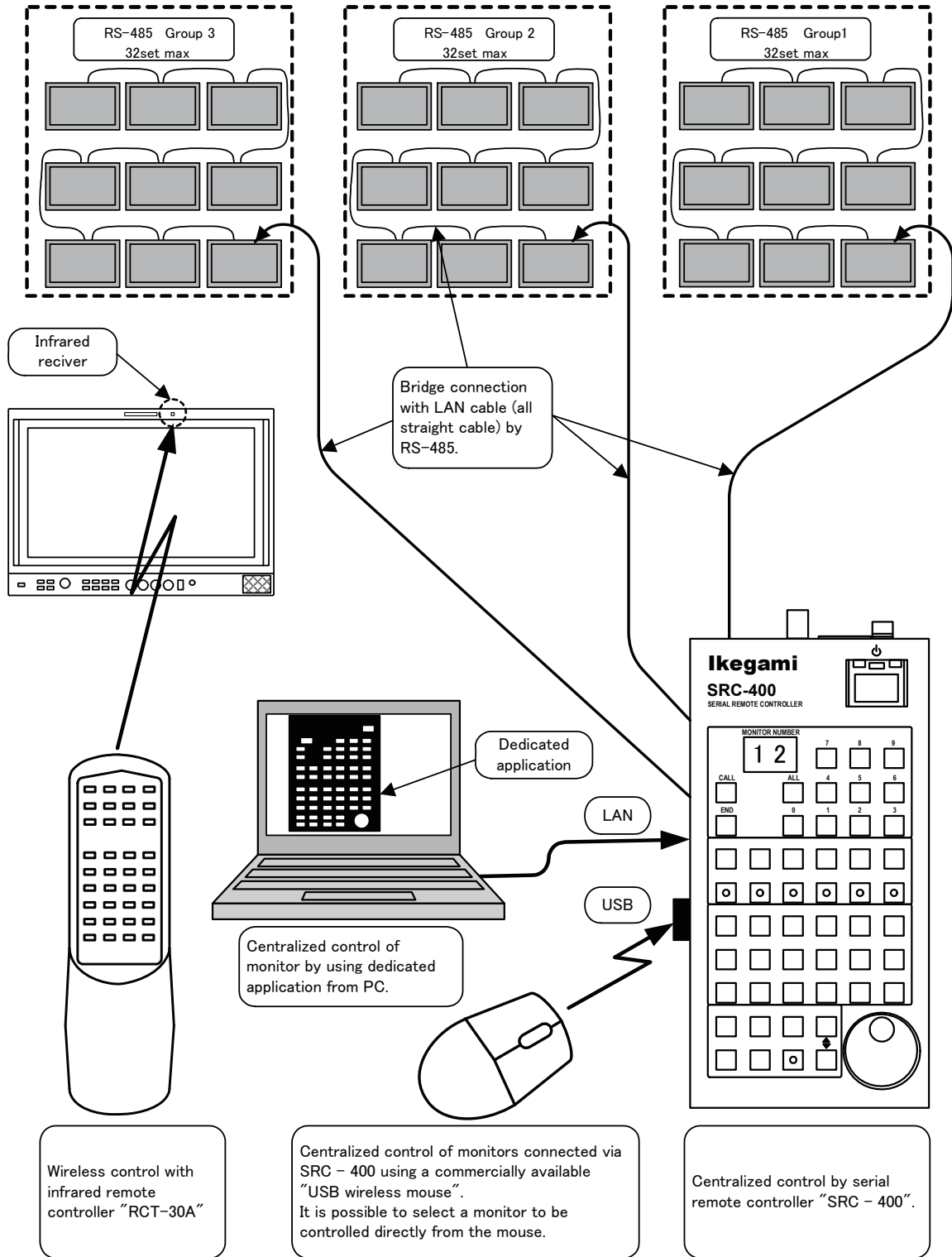

3. Markers

3-1. Types of Markers

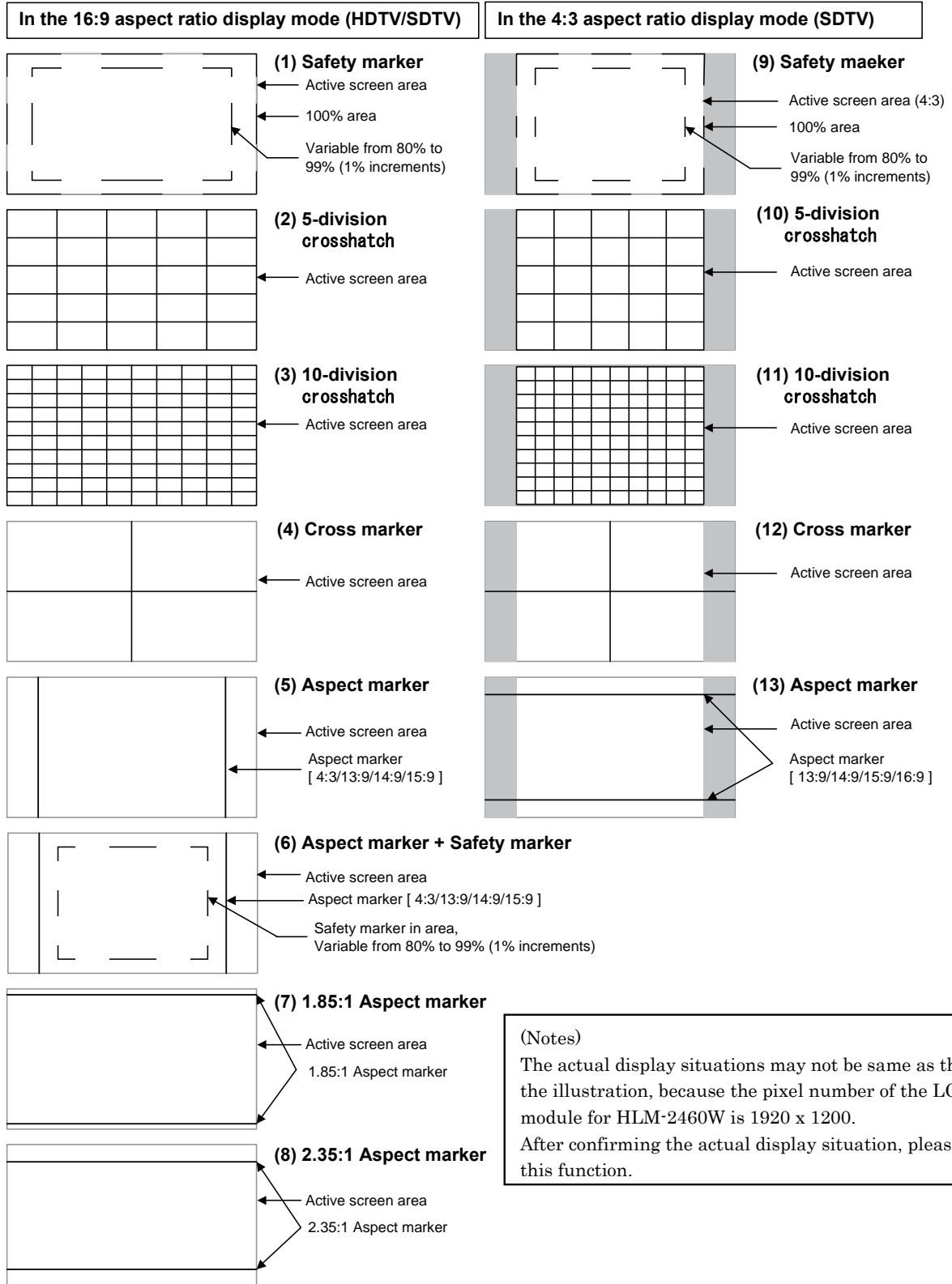

(Notes)
The actual display situations may not be same as those of the illustration, because the pixel number of the LCD module for HLM-2460W is 1920 x 1200.
After confirming the actual display situation, please use this function.

- The displayed markers are set in **MENU-MARKER**.
- There are two kinds of settings (1) (9): "FRM + SAFE" with 100% area marker and "SAFETY" without 100% area marker. The figure in (1) (9) is the setting state of "FRM + SAFE".

4. MENU Functions

4-1. MENU Outline

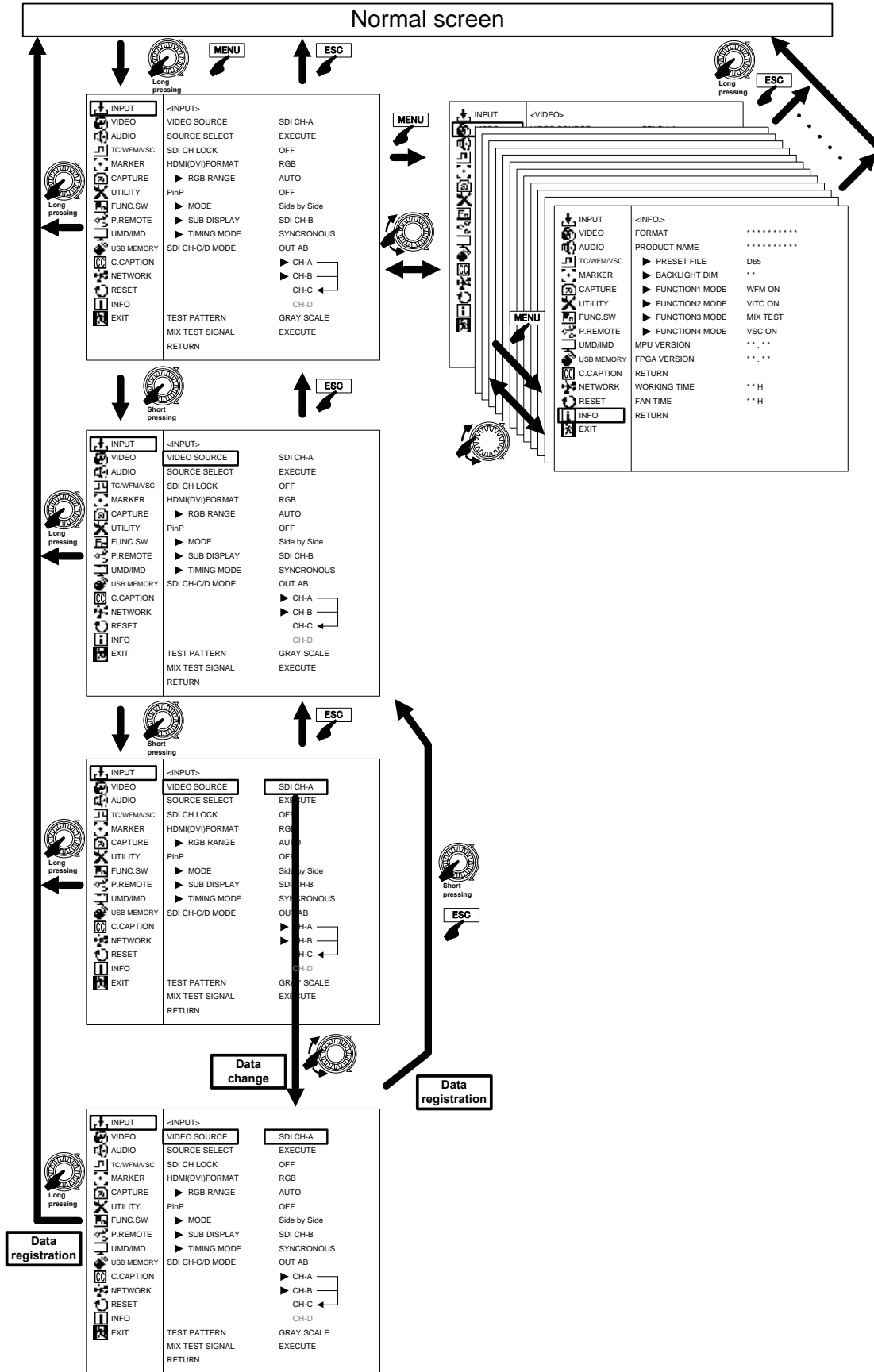

4-2. Description of MENU-INPUT Functions

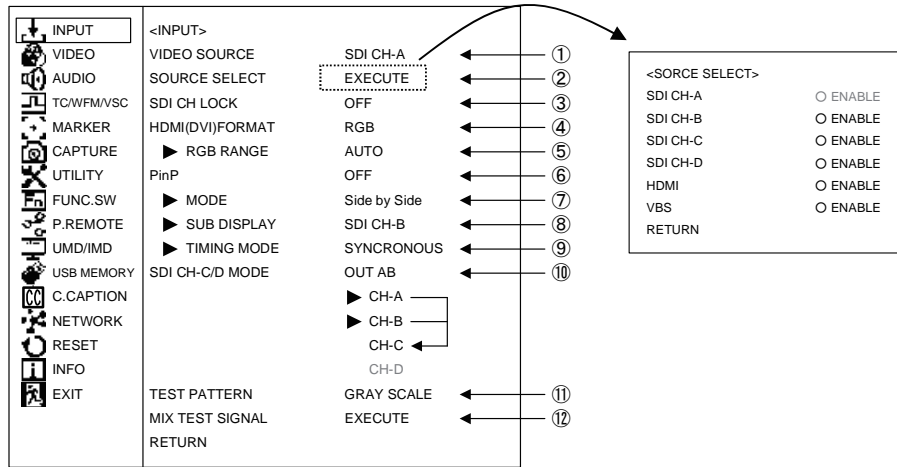

① Setting the VIDEO SOURCE

- Set the input signals to be displayed from "SDI CH-A/SDI CH-B/SDI CH-C/SDI CH-D/HDMI/VBS/TEST".
- The input signals that have been set to "DISABLE" as shown above are not displayed.
- "SDI CH-C/SDI CH-D" is displayed only when it is set to be an input in the menu.
- Default setting is SDI CH-A.

② Setting the SOURCE SELECT

- If you set input signals using the **S-INPUT** switch and **RE**, set the display to "×DISABLE" so that only required inputs can be quickly set.
 - ○ ENABLE : Enable
 - × DISABLE : Disable

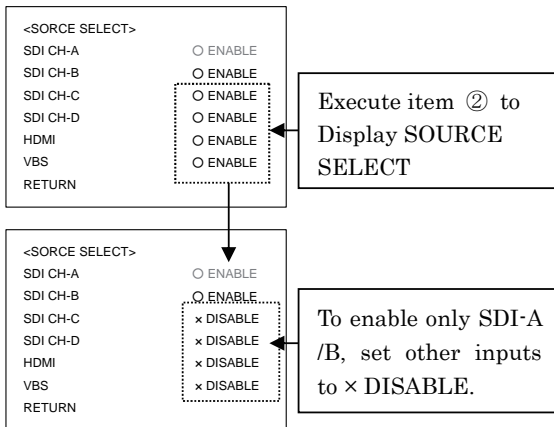

- Default setting is all inputs ○ENABLE.

③ ON/OFF setting of SDI CH Lock

- Set to "ON" to prevent the A/B/C/D input channel switching for SDI signals and fix the input channel.
- It is effective when the MONITOR OUT terminal is used and the channel needs to be fixed. It prevents switching the channel by mistake.

- * Before setting to "ON", select the SDI channel needed to be fixed.

- Default setting is OFF.

④ Setting RGB/YPbPr for HDMI(DVI) input

- The RGB/YPbPr setting is automatically recognized and set by HDMI signals from the packet information of the info frame regardless of this setting.
- There is no RGB/YPbPr information in the packet information if the signals are converted from DVI to HDMI signals. So, set RGB/YPbPr here.
- Default setting is RGB.

⑤ Setting the HDMI RGB range

- Set the black level and white level values in the RGB format of the HDMI signal.
 - FULL : 0 (black level) - 255 (white level)
 - LIMIT : 16 (black level) - 235 (white level)
 - AUTO : Set according to info frame packet information.
- Default setting is AUTO.

⑥ Setting the PinP ON/OFF

- This function simultaneously displays two input signals on two screens and turns on/off the display of PinP.
- It can be assigned to a FUNCTION key.
- * It supports identical format signals only.
- Default setting is OFF.

⑦ Setting the PinP mode

- Set the PinP mode.
- The main screen and sub screen can be displayed in the identical format only.
 - Main screen: Inputs set in the menu (VIDEO SOURCE)
 - Sub screen: Inputs set in the menu (SUB DISPLAY)
- * The TEST signals do not work.

* If the main screen and sub screen are connected to HDMI, the video of the sub screen will not be displayed

◆ Side by Side

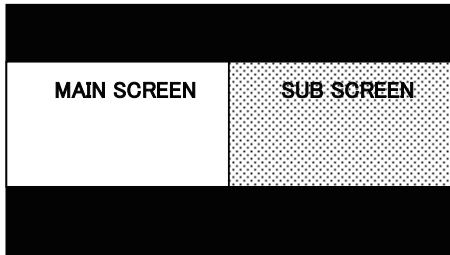

◆ Window(R)

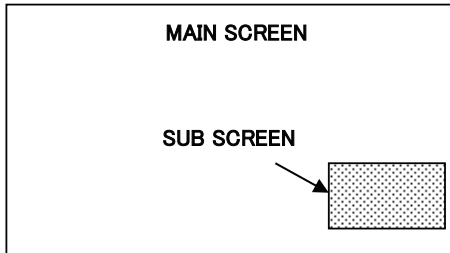

• When WFM/VSC is displayed at "RIGHT" position, the position of WFM/VSC is moved to the right side of the sub screen and it is displayed not to overlap.

◆ Window(L)

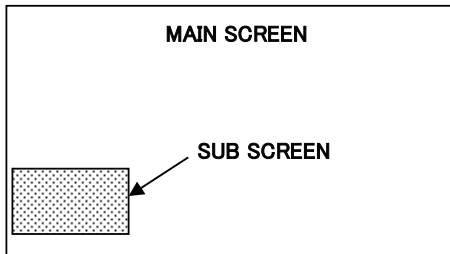

• When WFM/VSC is displayed at "LEFT" position, the position of WFM/VSC is moved to the right side of the sub screen and it is displayed not to overlap.

◆ Wipe (The ratio is displayed at the top of the screen)

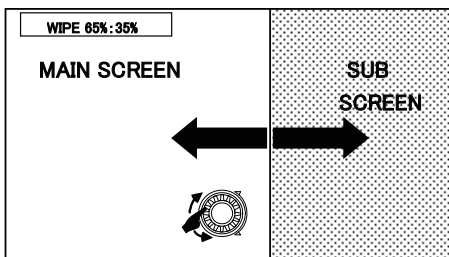

◆ Wipe(V) (The ratio is displayed at the top of the screen)

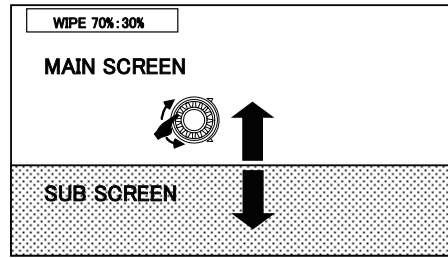

• Default setting is Side by Side.

⑧ Setting the SUB DISPLAY

- Setting the sub screen signal.
- Default setting is SDI CH-B.

⑨ Setting the TIMING MODE

- Set whether the two input signals are synchronized or asynchronous signals.
- SYNCHRONOUS : When the two signals are synchronized
- ASYNCHRONOUS : When the two signals are asynchronous
- * In "ASYNCHRONOUS", the sub screen is delayed by two frames.

• Default setting is SYNCHRONOUS.

⑩ Setting the SDI CH-C/D input/output

- SDI C / D can be set for input / output.
- The following 10 settings are possible.

◆ OUT AB

- SDI CH-C : CH-A/B output
- SDI CH-D : Disable

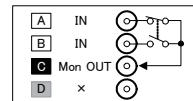

◆ OUT A / IN

- SDI CH-C : CH-A output
- SDI CH-D : input

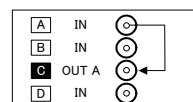

◆ OUT A / OUT B

- SDI CH-C : CH-A output
- SDI CH-D : CH-B output

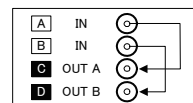

◆ OUT B / IN

- SDI CH-C : CH-B output
- SDI CH-D : input

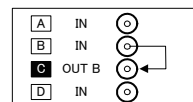

◆ OUT B / OUT A

- SDI CH-C : CH-B output
- SDI CH-D : CH-A output

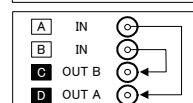

◆ IN / IN

- SDI CH-C : input
- SDI CH-D : input

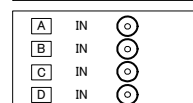

◆ IN / OUT A

- SDI CH-C : input
- SDI CH-D : CH-A output

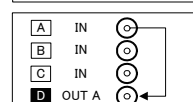

◆ IN / OUT B

SDI CH-C : input
SDI CH-D : CH-B output

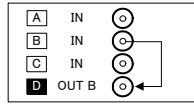

◆ IN / OUT C

SDI CH-C : input
SDI CH-D : CH-C output

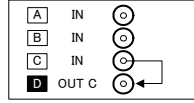

◆ IN / OUT ABC

SDI CH-C : input
SDI CH-D : CH-A/B/C output

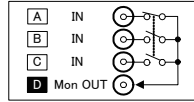

• Default setting is OUT AB.

⑪ Setting the TEST PATTERN

- Set the TEST signal to be displayed.
 - It can be set to the following 7 patterns.
 - Gray scale with pluge
 - Color Bar
 - 100% Window
 - 20% Gray
 - Pluge
 - Full Color Bar
 - -6.8~0%&100~109%
- Refer to 2-1 ⑥ for the pattern.
- Default setting is the GRAY SCALE.

⑫ Setting the MIX TEST SIGNAL

- By mixing the pluge signal (-2%/0%/+2%) and the 100% to 109% signal into the image, you can adjust the image in real time by checking if white part is not saturated due to the CONTRAST adjustment for the over 100% signal or if there is no crushed black effect caused by the BRIGHTNESS adjustment.
- This monitor automatically turns off the Mix Test signal display when the front volume is not operated for approximately one minute.
- This function can be assigned to a function switch on the front panel.

* Only SDI signals are supported.

• Default setting is OFF.

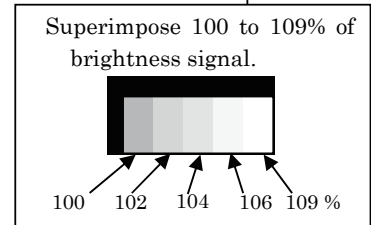
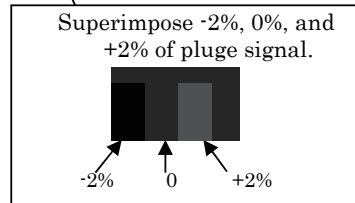

4-3. Description of MENU-VIDEO Functions

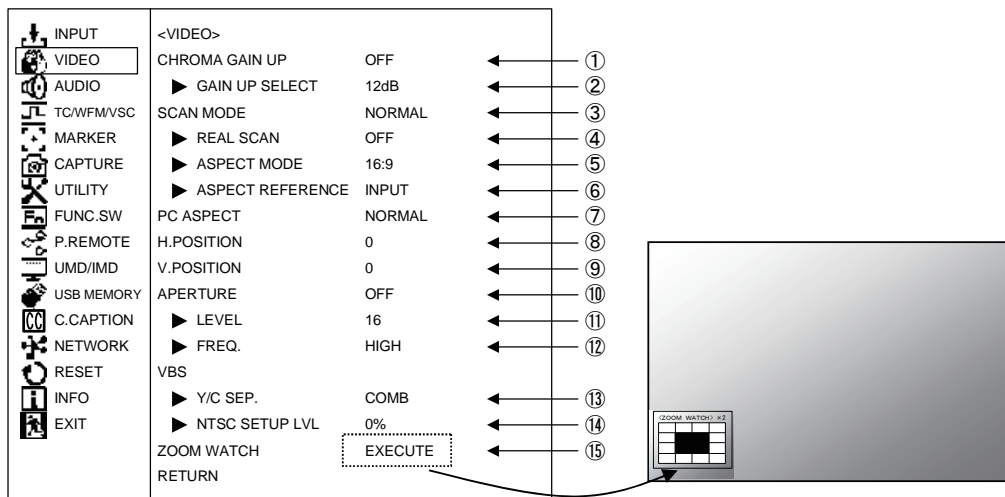

① Setting the chroma gain-up ON/OFF

- Set the gain-up ON/OFF for chroma.
- When Chroma Gain Up is On the chroma gain increases by "+9 dB or +12dB".
- This function can be assigned to a function switch on the front panel.
- Default setting is OFF.

② Setting the gain-up level (9db/12dB)

- Sets the Chroma Gain Up level.
- Selects the Chroma Gain Up level from "+9dB or +12dB".
- Default setting is +12dB.

③ Setting the scan mode (NORMAL/UNDER)

- Switches the image display size between NORMAL SCAN and UNDER SCAN.

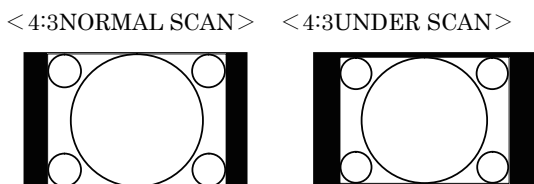
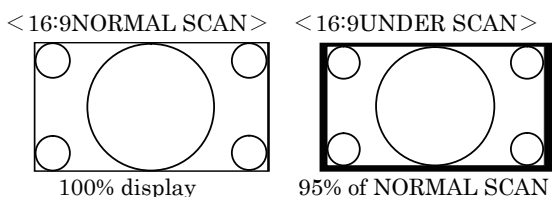

- This function can be assigned to a function switch on the front panel.
- * When "DISPLAY POSITION: AUTO" is set during UMD / IMD display, SCAN switching is disabled.
- Default setting is NORMAL.

④ Setting the REAL SCAN ON/OFF

- Set to ON in order to reproduce the input signal in its original pixels without enlargement or reduction.
- This function can be assigned to a function switch on the front panel.
- * Signals in 480i/576i format are not in square pixels. Therefore, the aspect ratio will be displayed differently from the original image.
- * Markers turn OFF with Real Scan On.
- Default setting is OFF.

⑤ Setting the ASPECT MODE (4:3/16:9)

- Use this switch to change image aspect ratios (4:3/16:9/ZOOM).
- * "ZOOM" magnifies the image area in the 4:3 letterbox.

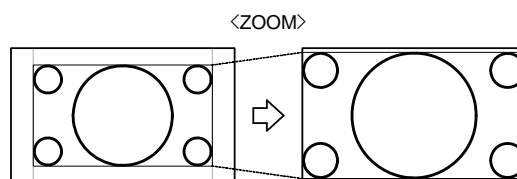

- * SDTV format signals (480i/576i) only are effective.
- Default setting is 4:3.

⑥ Setting the ASPECT REFERENCE

- Used to select automatic setting of a preset aspect ratio or a fixed setting for all input channels, when selecting input channels.
- INPUT : displayed with the set aspect ratio for each channel
- COMMON : displayed with the same aspect ratio for all channels

* When switching the ASPECT in the parallel remote mode, set the ASPECT ratio to "COMMON".

- Default setting is INPUT.

⑦ Setting the display size for PC signal with HDMI

- Used to preset the image display size in receiving a PC-format HDMI signal.
- This is effective when a HDMI input mode has been selected and the related signal is detected.
 - NORMAL : With the aspect ratio intact, images are enlarged or reduced to the panel's maximum displayable size.
 - FULL : Images are fully displayed on-screen (1920 x 1080) for all input signals.

- Default setting is NORMAL

- ◆ Display pixels with respect to PC input signals in each mode.

PC input signal (pixels, aspect ratio)	Pixel size and aspect ratio	
	NORMAL	FULL
VGA (640×480, 4:3)	1440×1080 (4:3)	1920×1080 (16:9)
SVGA (800×600, 4:3)	1440×1080 (4:3)	1920×1080 (16:9)
XGA (1024×768, 4:3)	1440×1080 (4:3)	1920×1080 (16:9)
WXGA (1280×768, 15:9)	1800×1080 (15:9)	1920×1080 (16:9)
SXGA (1280×1024, 5:4)	1350×1080 (5:4)	1920×1080 (16:9)
UXGA (1600×1200, 4:3)	1440×1080 (4:3)	1920×1080 (16:9)
WUXGA (1920×1200, 16:10)	1728×1080 (16:10)	1920×1080 (16:9)

⑧ Horizontal screen position adjustment

- Adjust the horizontal screen position of the input signal in the range of -100 to +100 (In HLM-2460W case : -30 to 30).
- The setting values are memorized for each channel/each format.
- ※For this setting, numerical values are not memorized in the "POWER ON CONFIG" function.
- Default setting is 0.

⑨ Vertical screen position adjustment

- Adjust the vertical screen position of the input signal in the range of -20 to +20.
- The setting values are memorized for each channel/each format.
- ※For this setting, numerical values are not memorized in the "POWER ON CONFIG" function.
- Default setting is 0.

⑩ Setting the APERTURE ON/OFF

- Set the APERTURE ON/OFF.
- This function can be assigned to a function switch on the front panel.
- Default setting is OFF.

⑪ Setting the APERTURE LEVEL

- Set the APERTURE level in the range from 1 to 63.
- Default setting is 16.

⑫ Setting the APERTURE frequency

- Set the boost frequency of APERTURE.
 - LOW Boost from around 10MHz
 - MID1 Boost from around 15MHz
 - MID2 Boost from around 20MHz
 - HIGH Boost from around 25MHz
- Default setting is HIGH.

⑬ Setting the COMB/TRAP of VBS

- Set the filter for Y / C separation of a VBS signal.
 - COMB COMB filter
 - TRAP TRAP filter
- This function can be assigned to a function switch on the front panel.
- Default setting is COMB.

⑭ Setting the setup level of the NTSC signal

- Sets the setup level when an NTSC signal is input. If the black level of the signal has 7.5% setup, set it to "7.5%".
- Default setting is 0%.

⑮ Executing the 2x/4x zoom function

- This is a function used to enlarge the image 2x or 4x.
- You can check for any defects in the camera image, as well as, fine details in the picture.
- * Supported formats are only 720p, 1080i, and 1080p.
- The display area to be enlarged is displayed on the left bottom of the screen.

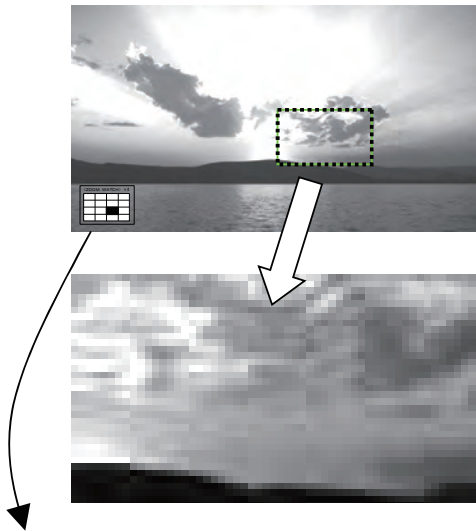

- The **RE** switch is used to switch between 2x and 4x.

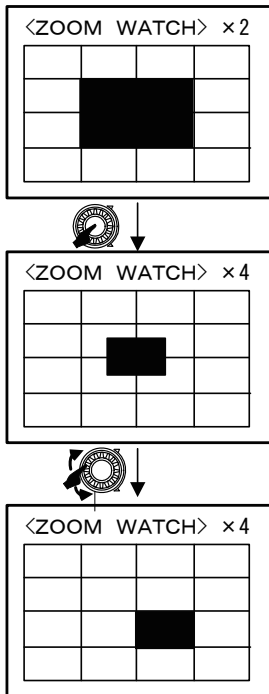

4-4. Description of MENU AUDIO Functions

INPUT	<AUDIO>		
VIDEO	LINE/SP CH.	CH1/2	①
AUDIO	SP INPUT SEL	AUTO	②
TC/WFM/VSC	LEVEL INDICATOR	OFF	③
MARKER	▶ MODE	1 (1 3 5 7 ? 2 4 6 8)	④
CAPTURE	▶ CHANNEL	CH1-8	⑤
UTILITY	▶ DIMMER	HIGH	⑥
FUNC.SW	▶ PEAK HOLD	ON	⑦
P.REMOTE	▶ REF LEVEL	-20dB	⑧
UMD/IMD	DOWNMIX SETTING		⑨
USB MEMORY	▶ FORMAT	IOS/IEC	⑩
C.CAPTION	▶ Ls/Rs LEVEL	-3dB	⑪
NETWORK	▶ INPUT OF Lm	CH1	⑫
RESET	▶ INPUT OF Rm	CH2	⑬
INFO	▶ INPUT OF C	CH3	⑭
EXIT	▶ INPUT OF Ls	CH5	⑮
	▶ INPUT OF Rs	CH6	⑯
	RETURN		

① Setting the channels of embedded audio for output

- Set any of the following pairs of channels of embedded audio to be output to the front speaker, the headphone jack and the rear audio monitor output.
 - CH1/2 : The output comes out of the paired CH1 and CH2 channels.
 - CH3/4 : The output comes out of the paired CH3 and CH4 channels.
 - CH5/6 : The output comes out of the paired CH5 and CH6 channels.
 - CH7/8 : The output comes out of the paired CH7 and CH8 channels.
 - DOWNMIX : The output comes out of downmix 5.1ch surround audio.
- This function can be assigned to a function switch on the front panel.
- Default setting is CH1/2.

- The number in parentheses shows the order of display channel.
- MODES 5 to 8 are obtained by doubling the width of MODES 1 to 4.
- MODE1 (1357-2468)

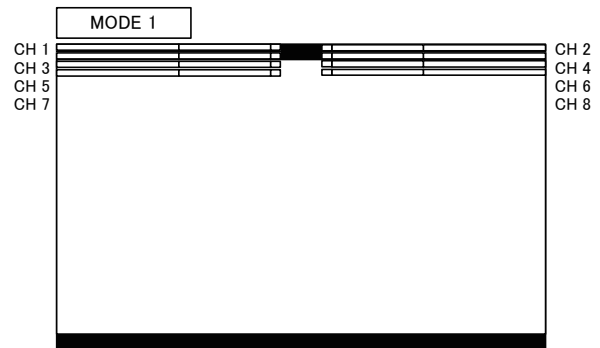

② Setting the speaker output signal

- Set the signals to be output to the speaker, the headphone jack, and the rear audio monitor output.
 - AUTO : embedded audio in the SDI and HDMI input modes, and analog in the VBS input mode
 - EMBEDDED : fixed at embedded audio
 - ANALOG : fixed at analog audio
- Default setting is AUTO.

- MODE2 (1234-5678)
- MODE3 (1357-8642)
- MODE4 (12-34) : During the display mode 1-2ch and 1-4ch settings.
- MODE4 (1234-5678) : During the display mode 1-8ch settings.
- * The display of MODE 4 depends on the number of channels for the section ⑤.

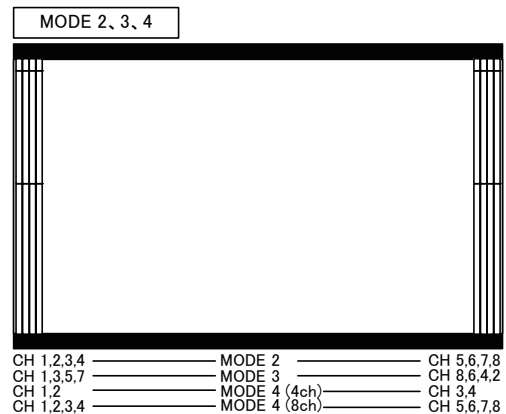

③ Setting the audio level meter display ON/OFF

- Used to turn on and off the audio level meter display.
- Default setting is OFF.

④ Setting the display mode of audio level metering

- Set the display mode of the audio level meter.

- MODE5 (1357-2468)

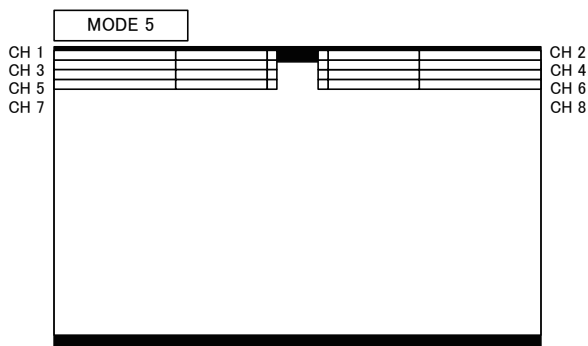

- MODE6 (1234-5678)
- MODE7 (1357-8642)
- MODE8 (12-34) : During the display mode 1-2ch and 1-4ch settings.
- MODE8 (1234-5678) : During the display mode 1-8ch settings.

* The display of MODE 4 varies depending on the number of channels for the section ⑤.

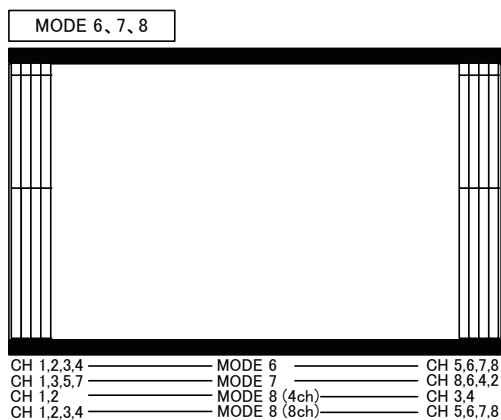

- Default setting is 1(1357-2468).

⑤ Setting the channel display of the audio level meter

- Set the display channel of the audio level meter.
 - CH 1-2 : CH1 to CH2 is displayed.
 - CH 1-4 : CH1 to CH4 is displayed.
 - CH 1-8 : CH1 to CH8 is displayed.
- Default setting is CH 1-8.

⑥ Setting the brightness of the audio level meter

- Set the brightness of the audio level meter.
- The level meter image transmissive mode or nontransmissive mode can be set.
 - LOW
 - MID
 - HIGH
 - LOW (MIX) (Image transmissive mode)
 - MID (MIX) (Image transmissive mode)
 - HIGH (MIX) (Image transmissive mode)
- Default setting is HIGH.

⑦ Setting the peak hold display of the audio level meter

- Used to turn on and off the peak hold display.
- Default setting is ON.

⑧ Setting the reference level

- Set the reference level of the audio level meter.
 - -18dBFS
 - -20dBFS
- Default setting is -20dBFS

⑨ Downmix setting

- Set the 5.1 channel surround downmix.
- Mix the 5.1 channel surround audio signal assigned to 6 channels of embedded audio into 2 channels, and output to the speaker, the headphone and the audio monitor output.
- 5.1ch surround sub woofer(LFE) channel is not mixed.

⑩ Setting the downmix formats

- Select the mixing method to downmix 5.1ch audio in “ISO/IEC” and “ARIB”.
- Default setting is ISO/IEC

⑪ Setting the Ls/Rs level

- Set the coefficient of Ls/Rs to mix.
- Set among -3dB/-6dB/-9dB/OFF. (OFF = $-\infty$)
- Default setting is -3dB

⑫ Setting the embedded audio channel assignment of speaker (Lm)

- Set the channel of embedded audio, which the audio for 5.1ch surround Lm speaker (left side in front) should be assigned from.
- Default setting is CH1

⑬ Setting the embedded audio channel assignment of speaker (Rm)

- Set the channel of embedded audio, which the audio for 5.1ch surround Rm speaker (right side in front) should be assigned from.
- Default setting is CH2

⑭ Setting the embedded audio channel assignment of speaker (C)

- Set the channel of embedded audio, which the audio for 5.1ch surround C speaker (center) should be assigned from.
- Default setting is CH3

⑮ Setting the embedded audio channel assignment of speaker (Ls)

- Set the channel of embedded audio, which the audio for 5.1ch surround Ls speaker (left side in rear) should be assigned from.
- Default setting is CH5

⑩ Setting the embedded audio channel assignment of speaker (Rs)

- Set the channel of embedded audio, which the audio for 5.1ch surround Rs speaker (right side in rear) should be assigned from.
- Default setting is CH6

4-5. Description of MENU-TC/WFM/SC Functions

- * TC is compatible only with SDI signal (except SD-SDI).
- * WFM / VSC is supported only for VBS and SDI signals.

INPUT	<TC/WFM/VSC>			
VIDEO	TC SELECT	OFF	←	①
AUDIO	▶ DIMMER	MIDDLE	←	②
TC/WFM/VSC	▶ SIZE	NORMAL	←	③
MARKER	WFM DISPLAY	OFF	←	④
CAPTURE	▶ DIMMER	HIGH(M)	←	⑤
UTILITY	▶ SIZE	NORMAL	←	⑥
FUNC.SW	▶ POSITION	RIGHT	←	⑦
P.REMOTE	▶ COLOR	WHITE	←	⑧
UMD/IMD	VECTOR SCOPE	OFF	←	⑨
USB MEMORY	▶ DIMMER	HIGH(M)	←	⑩
C.CAPTION	▶ MAGNIFICATION	x1	←	⑪
NETWORK	▶ SCALE	100%	←	⑫
RESET	▶ POSITION	RIGHT	←	⑬
INFO	▶ COLOR	WHITE	←	⑭
EXIT	RETURN			

① Setting the SDI TC display ON/OFF

- Used to turn ON or OFF the VITC/LTC display multiplexed with 3G/HD-SDI signal.
- This function can be assigned to a function switch on the front panel.
- Default setting is OFF.

② Setting of SDI TC display brightness

- Used to set the SDI TC display brightness in three levels, LOW, MID and HIGH.
- Default setting is MID.

③ Setting of SDI TC display size

- Used to select the SDI TC display size, NORMAL or LARGE.
- Default setting is NORMAL.



④ Setting of waveform display ON/OFF

- Used to turn ON or OFF the waveform display of luminance signal.
- This function can be assigned to a function switch on the front panel.
- Default setting is OFF.

⑤ Setting of waveform display brightness

- Used to set the waveform display brightness in three levels, LOW, MID, HIGH and HIGH(M).
- HIGH(M) mode transmits with a picture and displays it.
- Default setting is HIGH.

⑥ Setting of waveform display size

- Used to set the luminance signal waveform display size, NORMAL or SMALL.
- The SMALL setting displays the waveform half as tall as in the NORMAL setting.
- Default setting is NORMAL.

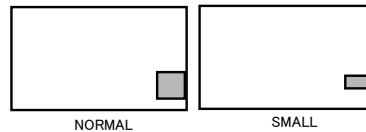

⑦ Setting of waveform display position

- Used to set the waveform display position, RIGHT, CENTER or LEFT.
- In the case of "RIGHT" setting, if the PinP function is set to "Window (R)" mode, the waveform display is displayed on the left side of the sub screen.
- In "LEFT" setting, when the PinP function is set to "Window (L)" mode, the waveform display is displayed on the right side of the sub screen.
- Default setting is RIGHT.

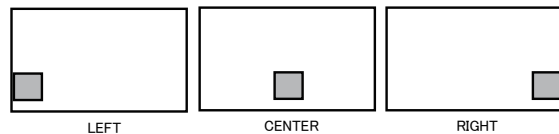

⑧ Setting the waveform display color

- Used to set the waveform display color, GREEN or WHITE.
- Default setting is WHITE.

⑨ Setting the VECTOR SCOPE display ON/OFF

- Used to turn on or off the VECTOR SCOPE display.
- This function can be assigned to a function

switch on the front panel.

- Default setting is OFF.

⑩ Setting the VECTOR SCOPE display brightness

- Used to set the VECTOR SCOPE display brightness in 3 levels: LOW, MID, HIGH and HIGH(M).
- HIGH(M) mode transmits with a picture and displays it.
- Default setting is HIGH.

⑪ Setting the VECTOR SCOPE display magnification ratio

- Used to set the VECTOR SCOPE display magnification in 4 ratios: x1, x2, x4 and x8.
- Default setting is x1.

⑫ Setting the COLOR BOX scale display

- Used to set the VECTOR SCOPE's COLOR BOX according to the input color bar signal: 75% and 100%.
- Default setting is 100%.

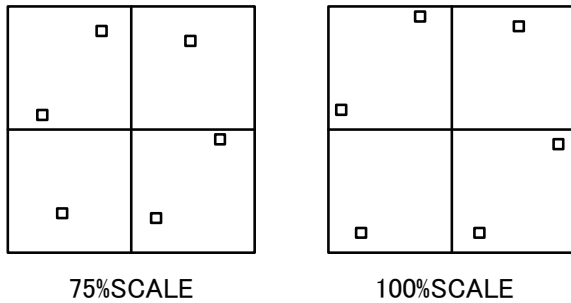

⑬ Setting the VECTOR SCOPE display position

- Used to set the vector display to any of the RIGHT, CENTER and LEFT positions.
- When used in common with the WFM, the VECTOR display is located on the left of the WFM one.
- In the case of "RIGHT" setting, if the PinP function is set to "Window (R)" mode, the vector display is displayed on the left side of the sub screen. In "LEFT" setting, when the PinP function is set to "Window (L)" mode, the vector display is displayed on the right side of the sub screen.
- Default setting is RIGHT.

• RIGHT location

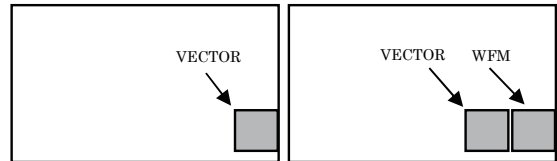

• CENTER location

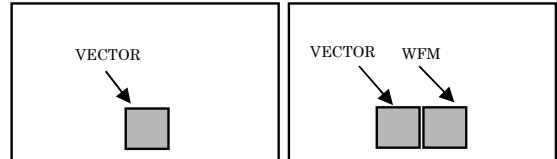

• LEFT location

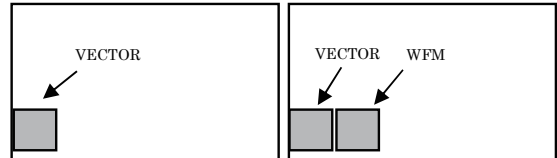

⑭ Setting the VECTOR SCOPE display color

- Used to set the vector display color to either of GREEN and WHITE.
- Default setting is WHITE.

4-6. Description of MENU-MARKER Functions

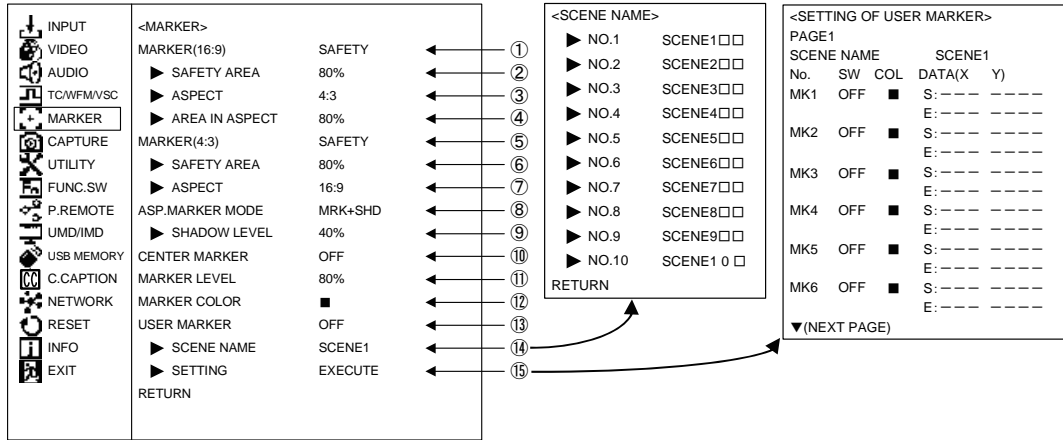

① Setting the type of marker (at 16:9 aspect ratio)

- Used to set various types of markers displayed at 16:9 aspect ratio.
- SAFETY : Displaying the safety marker preset in Item ② .
- FRM+SAFE: Displaying the safety marker (with 100% frame) preset in Item ②
- CROSS5 : 5-split crosshatch pattern.
- CROSS10 : 10-split crosshatch pattern.
- C.CROSS : Cross marker.
- ASPECT : Displaying the aspect marker preset in Item ③ .
- ASP+SAF : Displaying the aspect marker preset in Item ③ and the safety marker in aspect marker area preset in Item ④.
- This function can be assigned to a function switch on the front panel.

• Default setting is SAFETY.

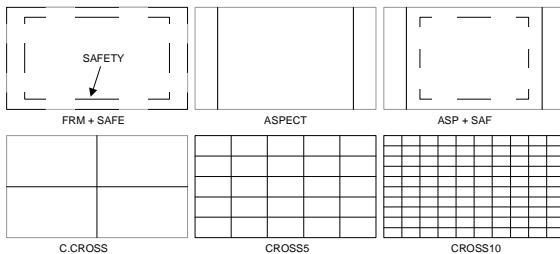

② Setting the safety marker area (at 16:9 aspect ratio)

- Used to set the safety marker area in the 80% - 99% range with 1% increments at 16:9 aspect ratio.

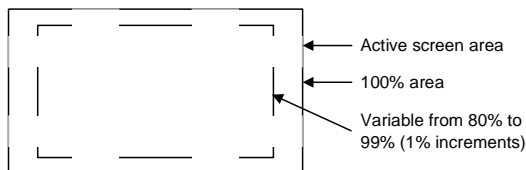

• Default setting is 80% (safety area).

③ Setting the type of aspect marker (at 16:9 aspect ratio)

- Used to select the type of aspect marker from “4:3, 13:9, 14:9, 15:9, 1.85:1 and 2.35:1” at 16:9 aspect ratio.

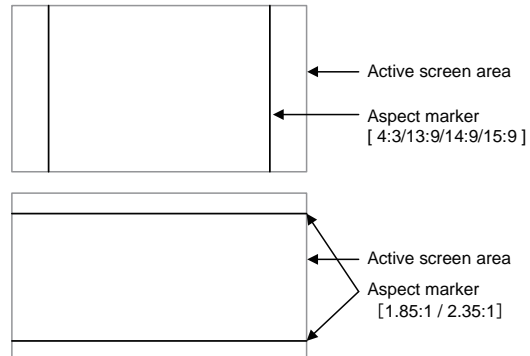

• Default setting is 4:3 marker.

④ Setting the safety marker area in aspect marker area (at 16:9)

- Used to set the safety marker in the aspect marker (4:3, 13:9, 14:9 and 15:9) area in the 80%-99% range with 1% increments at 16:9 aspect ratio.

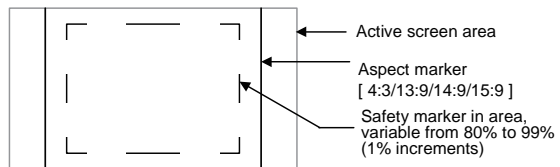

• Default setting is 80% (safety area).

⑤ Setting the type of marker (at 4:3 aspect ratio)

- Used to set various types of markers displayed at 4:3 aspect ratio.
- SAFETY : Displaying the safety marker preset in Item ⑥ .
- FRM+SAFE: Displaying the safety marker (with 100% frame) preset in Item ②

- ASPECT : Displaying the aspect marker preset in Item ⑦.
 - C.CROSS : Cross marker.
 - CROSS5 : 5-split crosshatch pattern.
 - CROSS10 : 10-split crosshatch pattern.
- This function can be assigned to a function switch on the front panel.
- Default setting is SAFETY.

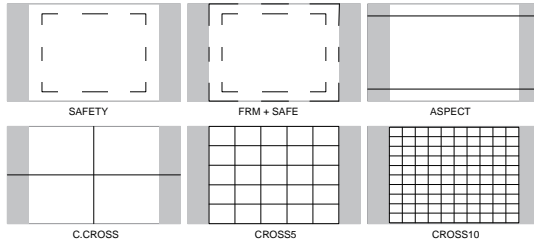

⑥ Setting the safety marker area (at 4:3 aspect ratio)

- Used to set the safety marker area in the 80%-99% range with 1% increments at 4:3 aspect ratio.
- Default setting is 80% (safety area).

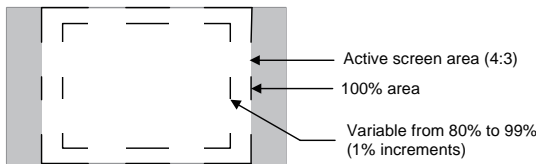

⑦ Setting the type of aspect marker (at 4:3 aspect ratio)

- Used to select the type of aspect marker from “13:9, 14:9, 15:9 and 16:9” at 4:3 aspect ratio.
- Default setting is 16:9 marker.

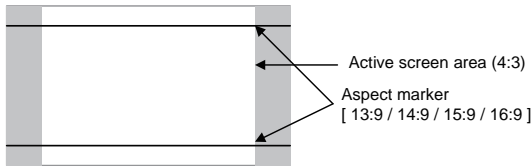

⑧ Setting the aspect marker display mode

- Used to set the aspect marker display mode.
- MARKER : Displaying the marker only.
- SHADOW : Displaying the shadow only
- MRK+SHD : Displaying both the marker and shadow
- Default setting is MARKER+SHADOW.

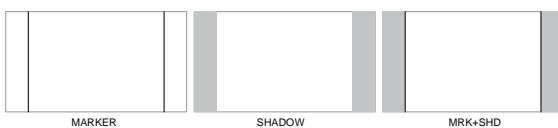

⑨ Setting the aspect marker shadow level

- Used to set the contrast level of the aspect marker shadow, when displayed.
- Settings: 0%, 20%, 40% and 60%
- Default setting is 40%.

⑩ Setting the center marker ON(TYPE-A/B)/OFF

- Used to turn on and off the center cross marker.
- There are two kinds of center markers TYPE-A or TYPE-B.
- Default setting is OFF.

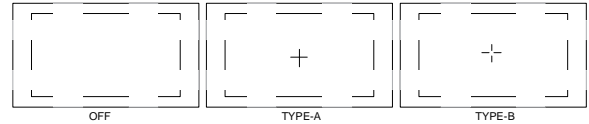

⑪ Setting the marker display level

- Used to set the marker display level.
- Settings: 20%, 40%, 60%, 80% and 100%
- Default setting is 80%.

⑫ Setting the marker display color

- Used to set the marker display color.
- * The marker is displayed in the color preset on the marker menu.
- Settings : White, yellow, cyan, green, magenta, red and blue
- Default setting is white.

⑬ Setting the user marker display ON/OFF

- Used to turn on and off the user marker display.
- This function can be assigned to a function switch on the front panel.
- Default setting is OFF.

⑭ Selecting each scene of user markers and setting the scene names

- The user markers can be set for up to 10 scenes; you can select from SCENE 1 to SCENE 10.

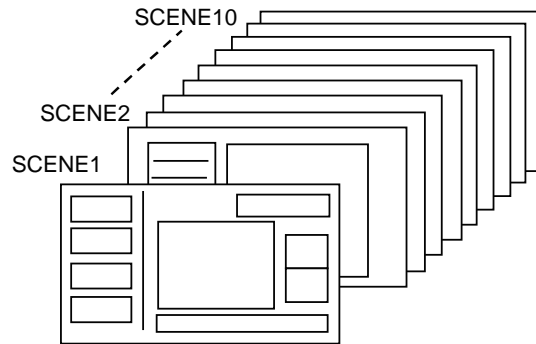

- The name of each scene can be up to 8 characters in length with the following characters: "0-9, A-Z, 0, -, □ (blank)".
- If you press ENT on the SCENE, the following SETTING MENU is displayed, and there you can change the name of each SCENE.

15 Setting User Markers

- Press **RE** with EXECUTE, and the user marker setting menu shows up. Now various settings can be made in this menu.
- For details, refer to Item 4-7.

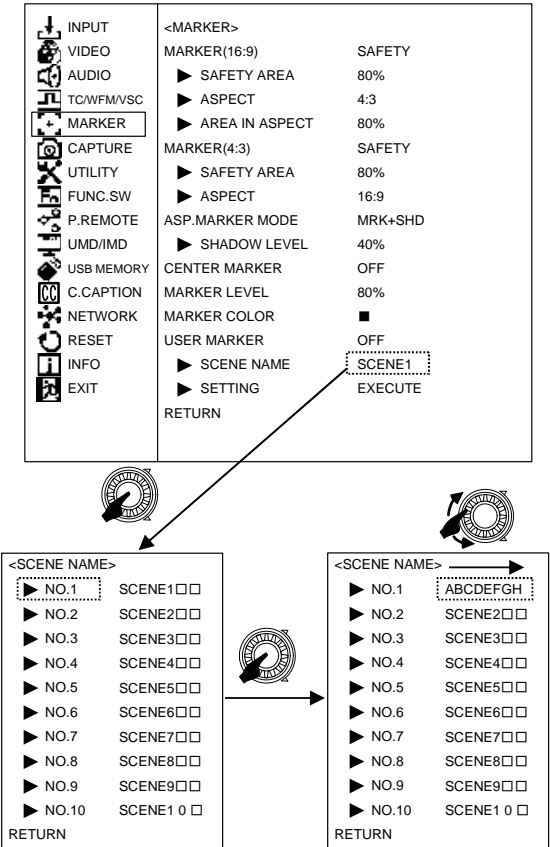

- The switching of the scenes can be assigned to a function switch on the previous screen.
- Default setting is SCENE1.

4-7. Description of MENU8-15 (USER MARKER) Functions and Setup

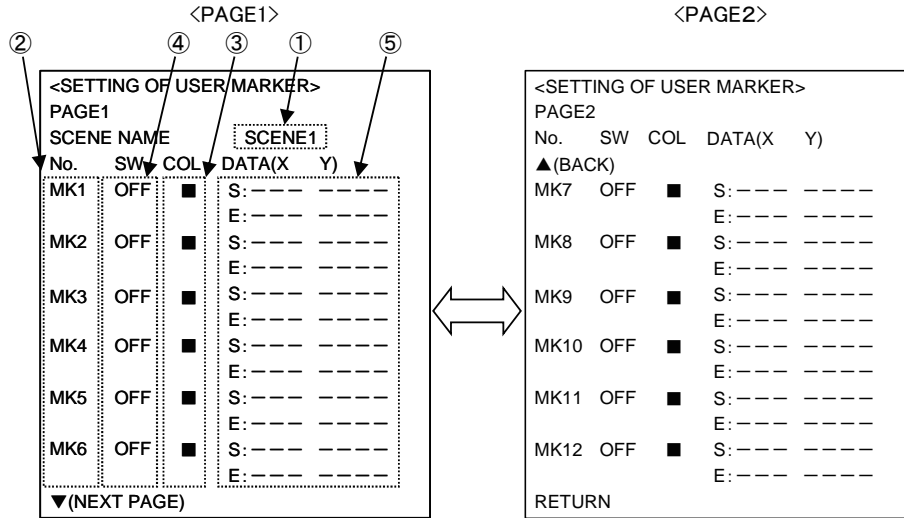

① The scene name for user marker

- The scene name of the user marker to be set is displayed, and you can use **RE** to change the scene.

② Types of user markers

- The user markers are presettable in boxes or lines, chosen from 12 types from MK1 to MK12. Up to 12 different display positions of subtitles can therefore be individually preset, depending on programs.
- Use the **RE** to select a desired item.

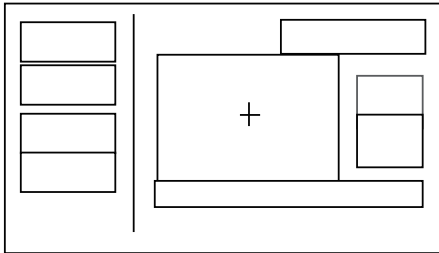

③ Setting the user marker color

- In the "COL" column, select a desired display color from 7 colors. The 12 types of user markers can be color-coded to identify them if two or more user markers are used.
- Settings : White, yellow, cyan, green, magenta, red and blue
- Default setting is white.

④ Setting the user marker display ON/OFF

- In the "SW" column, the display can be turned on and off.
- Default setting is ON.

⑤ User marker coordinates

- In the "DATA (X Y)" column, the coordinates for **S : START POINT** and **E : END POINT** of the currently set user markers are displayed. without such settings, the "-" marker appears.
- Move the cursor to the X/Y data. Using the **RE**, new user markers can be drawn or already registered user markers can be modified.
- The setting can be made in 1-pixel increments. The top left of the effective screen serves as the reference point (0001, 0001) of the coordinates. From this point, the coordinates can be adjusted in the pixel range of 1920 x 1080.
- * The pixel range of HLM-2460W is 1920 x 1200.

- Default setting is **-(unregistered)**.

●Resetting the data

Turn the **RE** counter-clockwise while “DATA(X Y)” in ⑤ is flashing to reset data that has been set to change to unregistered status (-).

In the case of using a mouse, scroll wheel up to unregister.

●Coordinate reference point

This 1920 x 1080, Full-HD panel has a pixel reference point (0001, 0001) at the top left of the screen. The pixel at the bottom right of the screen is preset as the coordinates (1920, 1080).

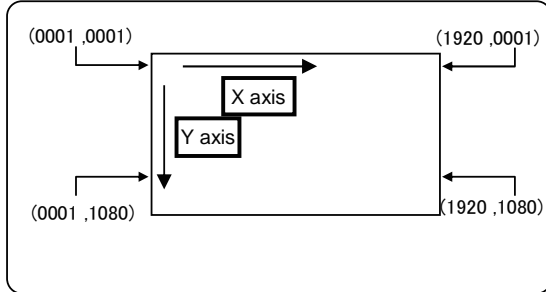

* Regarding HLM-2460W, the pixel at the bottom right of the screen is preset as the coordinates (1920, 1200).

●Marker lines and coordinate values

There are 4 line widths for the user markers. However, the coordinate for the start point and that for the end point are different by 3 pixel.

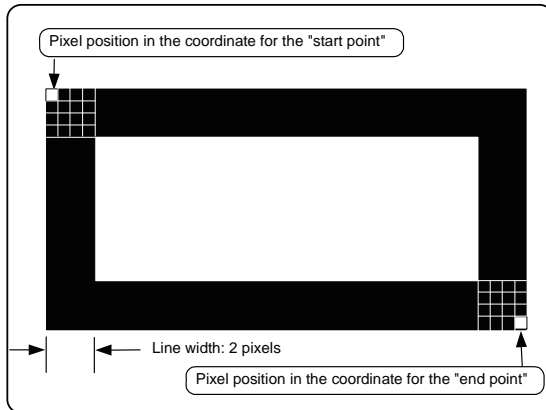

Accordingly, in drawing a horizontal line, the Y-direction address has a coordinate value with 3pixel added, as shown below.

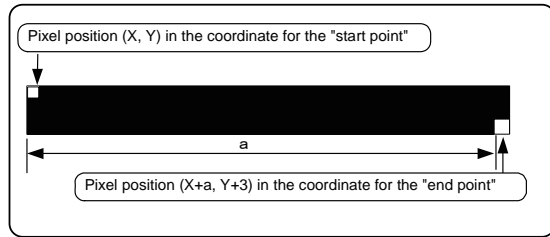

When a vertical line is drawn, the X-axis address has a coordinate value with 3 pixel added, as shown below.

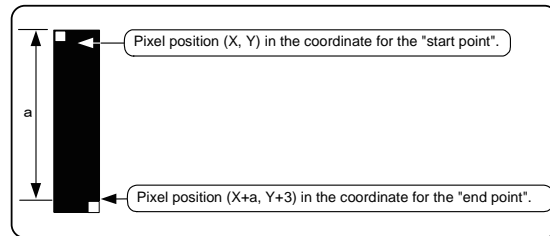

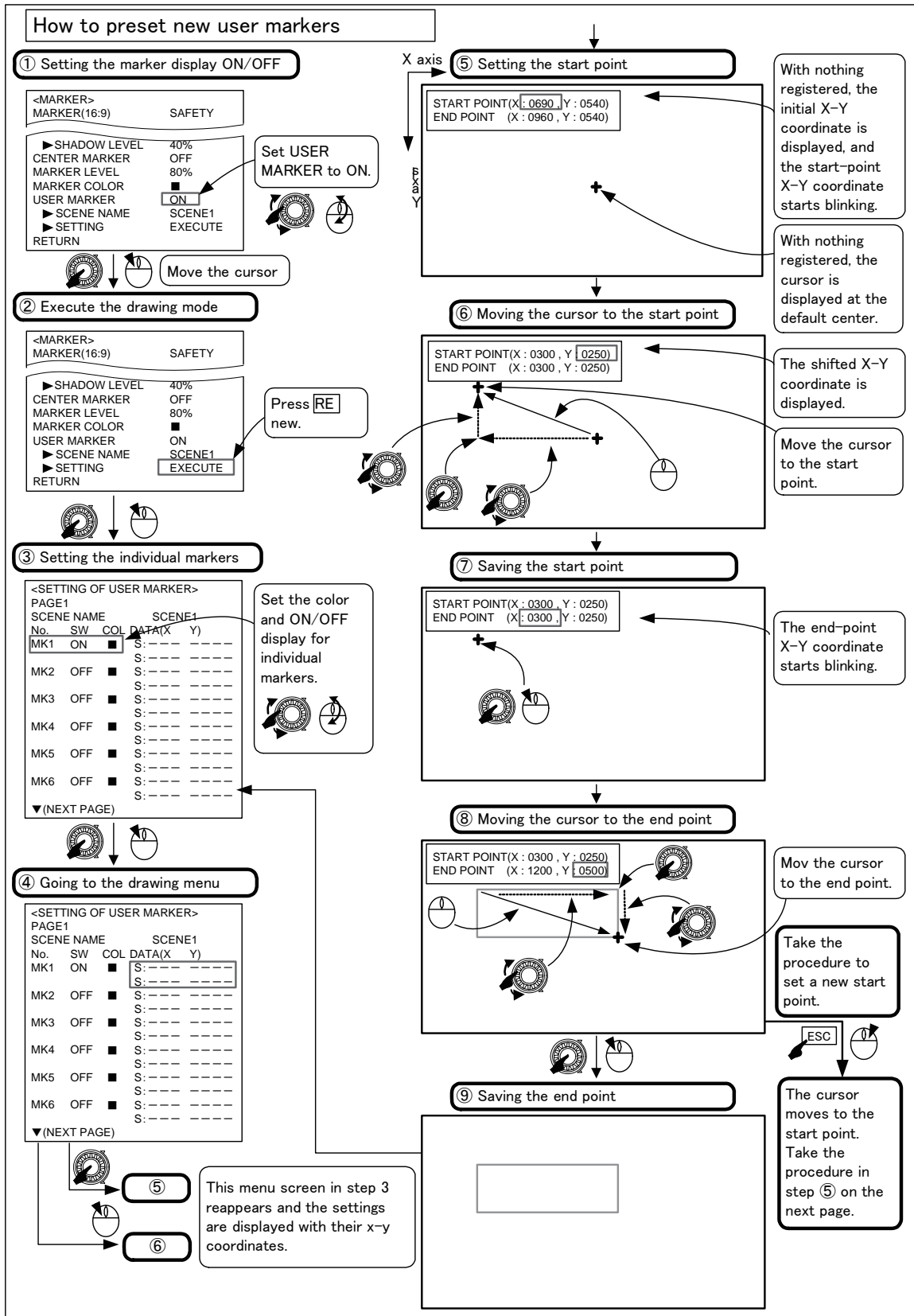

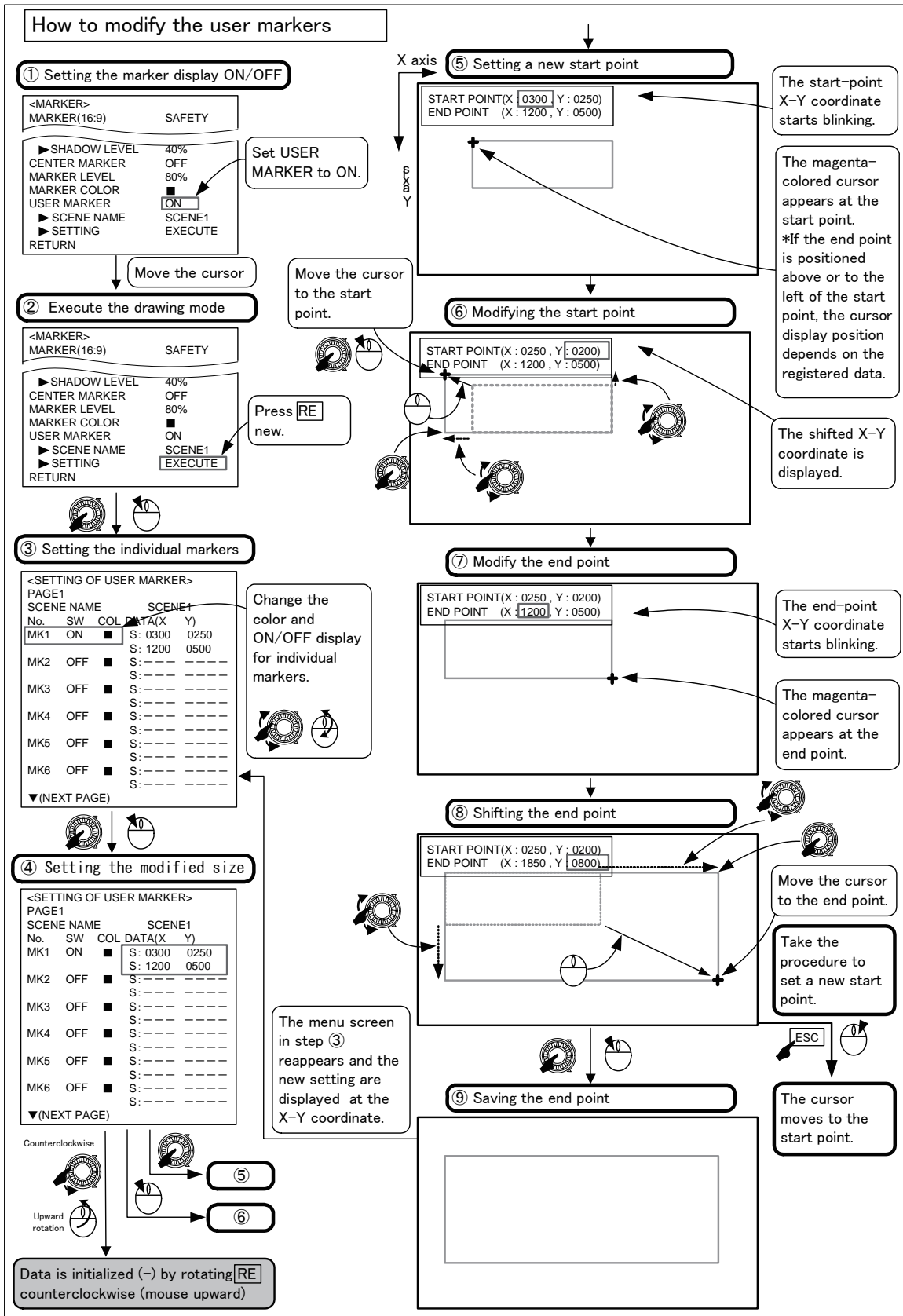

4-8. Description of MENU-CAPTURE Functions

INPUT	<CAPTURE>	EXECUTE	← ①
VIDEO	SCR CAPTURE	FULL	← ②
AUDIO	▶ AREA	EXECUTE	← ③
TC/WFM/VSC	FULL CAPTURE	EXECUTE	← ④
MARKER	CHG MANUAL	EXECUTE	← ⑤
CAPTURE	CHG AUTO	EXECUTE	← ⑥
UTILITY	▶ INTERVAL	5V	← ⑦
FUNC.SW	<TO USB MEMORY>	1	← ⑧
P.REMOTE	FILE NO.	EXECUTE	← ⑨
UMD/IMD	SAVE DATA	EXECUTE	
USB MEMORY	LOAD DATA	EXECUTE	
C.CAPTION	RETURN		
NETWORK			
RESET			
INFO			
EXIT			

① Executing the 2-picture split screen mode

- Used to execute this mode to capture a still image of an input signal and compare it with other live inputs.

- With “EXECUTE” flashing in magenta, press the **RE**.
- The display changes as shown below. Press the **RE** again to capture the image.

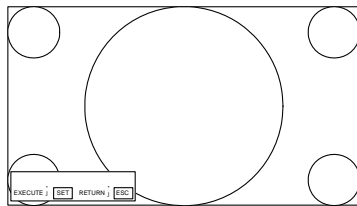

- Switch the input and compare its image with the taken-in still image. To take in another image or to quit the 2-picture split screen mode, press the **ESC** switch.

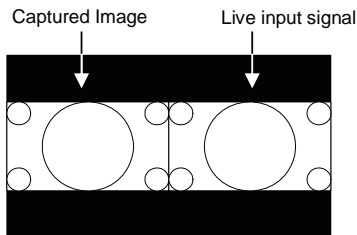

- The 2-picture split screen mode operates with signals of the same format. If different-format signals are input, the images cannot be properly displayed.
- With ASPECT set at [16:9], an SDTV signal is converted to [4:3].

② Setting the 2-picture split screen display area

- Used to set the display area in the 2-picture split screen mode.
 - FULL: Full image displayed

- 4:3: Image in the central 4:3 area displayed
- Default setting is FULL.
- * This function operates with HDTV-format input signals only.

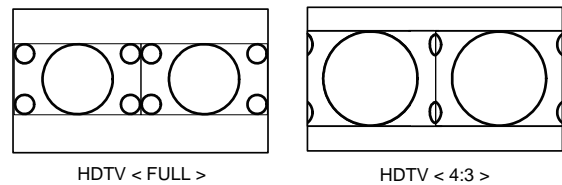

③ Executing the full capture mode

- This mode enables capturing the image that has been input in the full-screen mode.
- When the EXECUTE command is given, the MENU will appear at the lower left hand corner of the screen. When the **RE** is pressed, the full screen image will be captured. By pressing the **ESC** switch, the Input Signal mode will be resumed.

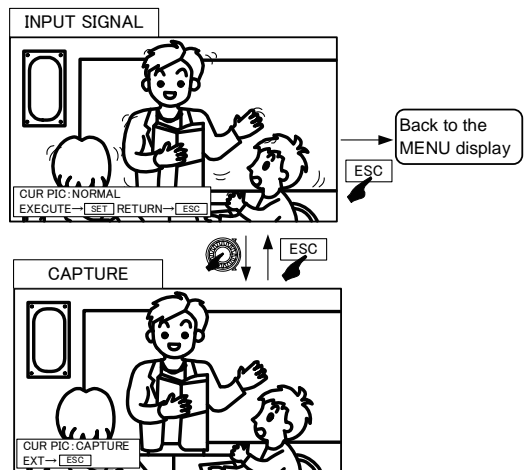

- This function can be assigned to a function switch on the front panel.

- * When the power is turned OFF, the captured image will be lost. If it is desired to save it for future use, follow item ⑧ to store it in a USB memory, and download it from the memory when you want to use it.

④ Manual switching mode between full capture image and input signal image

- This operation is possible after the full capture mode described under item ③ has been executed.
- Whenever the **RE** is pressed, the full capture image and the image of the input signal will be instantly switched over as illustrated on the diagram at left, making it possible to compare the images.
- By selecting a preferred moment to change over the switch, it is possible to ascertain the comparison of color/brightness/picture quality/position, etc. on a partial basis.
- This function can be assigned to a **F1** to **F4** switch on the front panel.
- * The comparison of the image of the input signal and the captured image can be performed only if both images are in the same format. The comparison cannot be performed if the formats of images of the input signal and the captured image are different, or if the captured image has not been stored in the memory of the monitor.

⑤ Automatic switching mode between full capture image and input signal image

- This operation is possible after the full capture mode described under item ③ has been executed.
- The full capture image and the image of the input signal will be automatically switched over, making it possible to compare the images.
- As images are switched over automatically, it is possible to carry out adjustments such as positioning at ease while operating the camera.
- The automatic switching can be set up by frame according to the procedure described under item ⑥.
- This function can be assigned to a function switch on the front panel.
- * The comparison of the image of the input signal and the captured image can be performed only if both images are in the same format. The comparison cannot be performed if the formats of the input signal image and the capture image should differ, or if the captured image has not been stored in the memory of the monitor.

⑥ Setting up the interval of the automatic switching mode

- This operation is possible after the full capture mode described under item ③ has been executed.
- The interval of the automatic switching mode can be specified by a unit of frame as shown below: .
1 FRAME→2 FRAMES→3 FRAMES→5 FRAMES
→10 FRAMES→30 FRAMES→60 FRAMES→
- Default setting is 3 FRAMES.

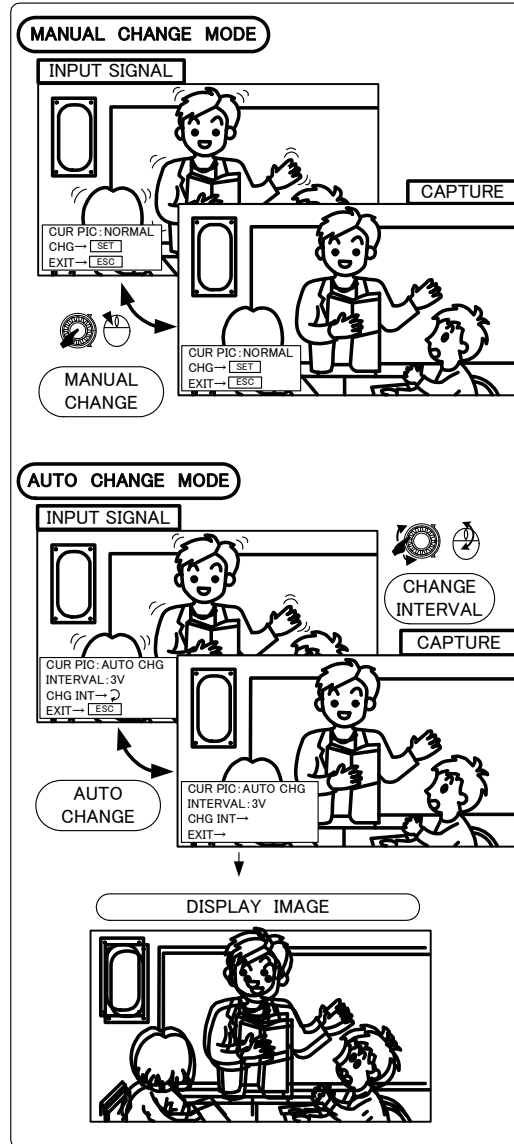

⑦ Setting the file number of the full capture image

- This feature is used to specify the file number (1~100) to be used when storing a full capture image in the USB memory. When downloading an image from the USB memory, the number is used to identify the desired image file.

⑧ Writing the full capture image onto the UBS memory

- Since it is possible to take in up to 100 images, test signals and other required images can be stored in the USB memory in advance before going out on an outdoor production for downloading and utilizing them on the location site.
- In case data is stored in a PC and later restored onto the USB memory, the required data should be placed in the root of the USB.
- It takes approximately 1 minute to write.
- For details of the method of writing data on the USB memory, please refer to “How to write full capture data from monitor to USB memory” on page 29.
- * Images captured with HDMI signals can not be saved to USB memory
- * Use the USB memory formatted with FAT32.
- * In addition, any USB memory on which some security measure has been executed cannot be used on this monitor.
- * Some memories do not work depending on the USB memory, so in that case please check with another USB memory.

Concerning file names

- When saving the full screen capture video in the USB memory, it is saved to the root in the USB memory with the following file name.

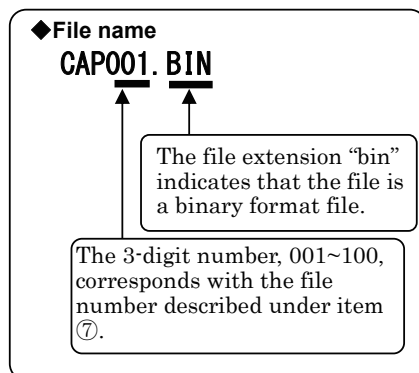

- The file format is dedicated to the monitor.
- The file size of one image is about 10 Mbytes.

Concerning dates used for stored files

- Since the monitor does not have any built-in clock, “the date,” and “the time” that have been set up under **MENU-USB-MEMORY** will apply.

⑨ Downloading from UBS memory to monitor

- Downloading the capture image stored in the USB memory to the monitor
- It takes approximately 3-5 minutes to download.
- For details of the method of downloading the capture image from the USB memory to the monitor, please refer to “How to download full capture data from USB memory to monitor” .

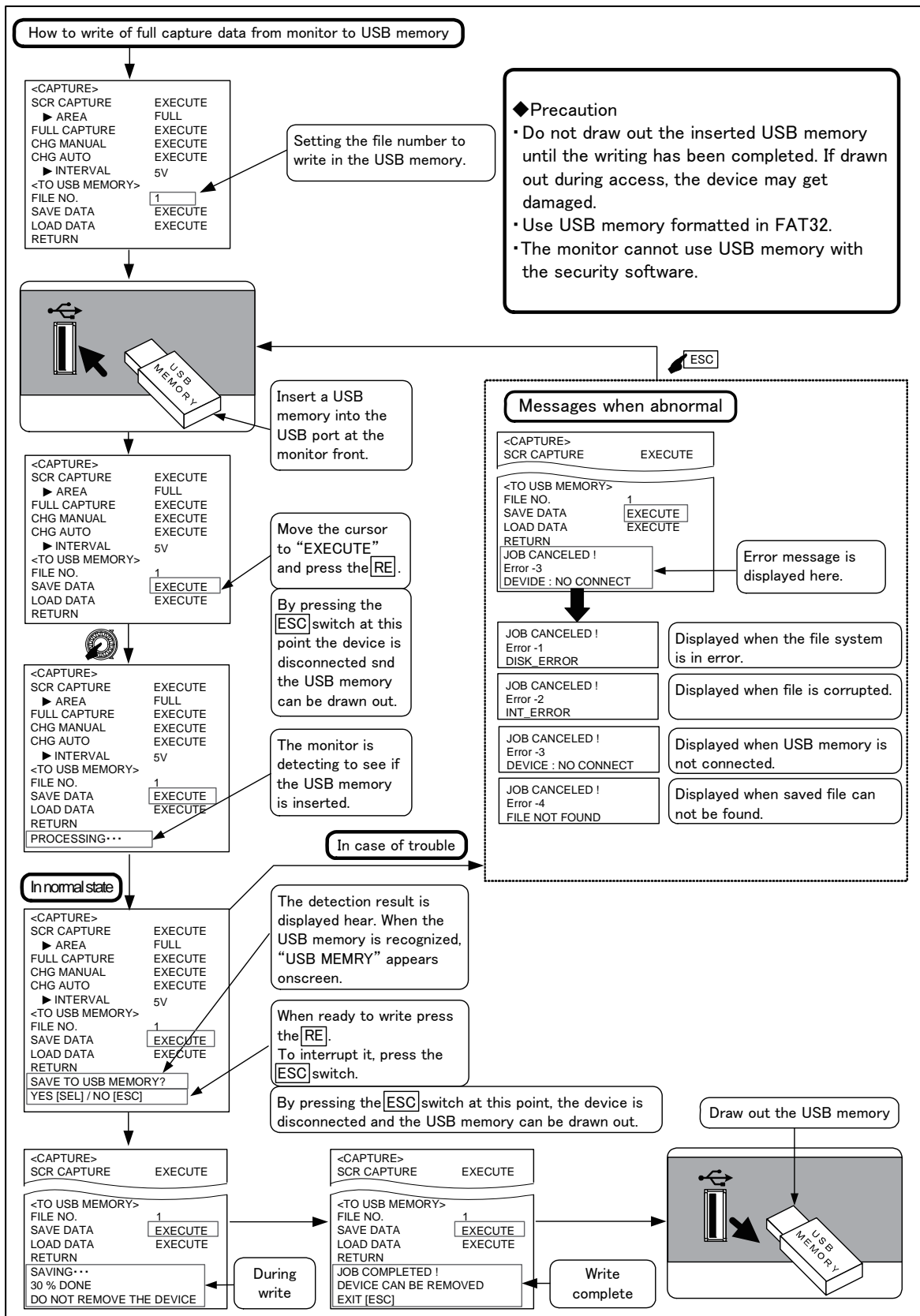

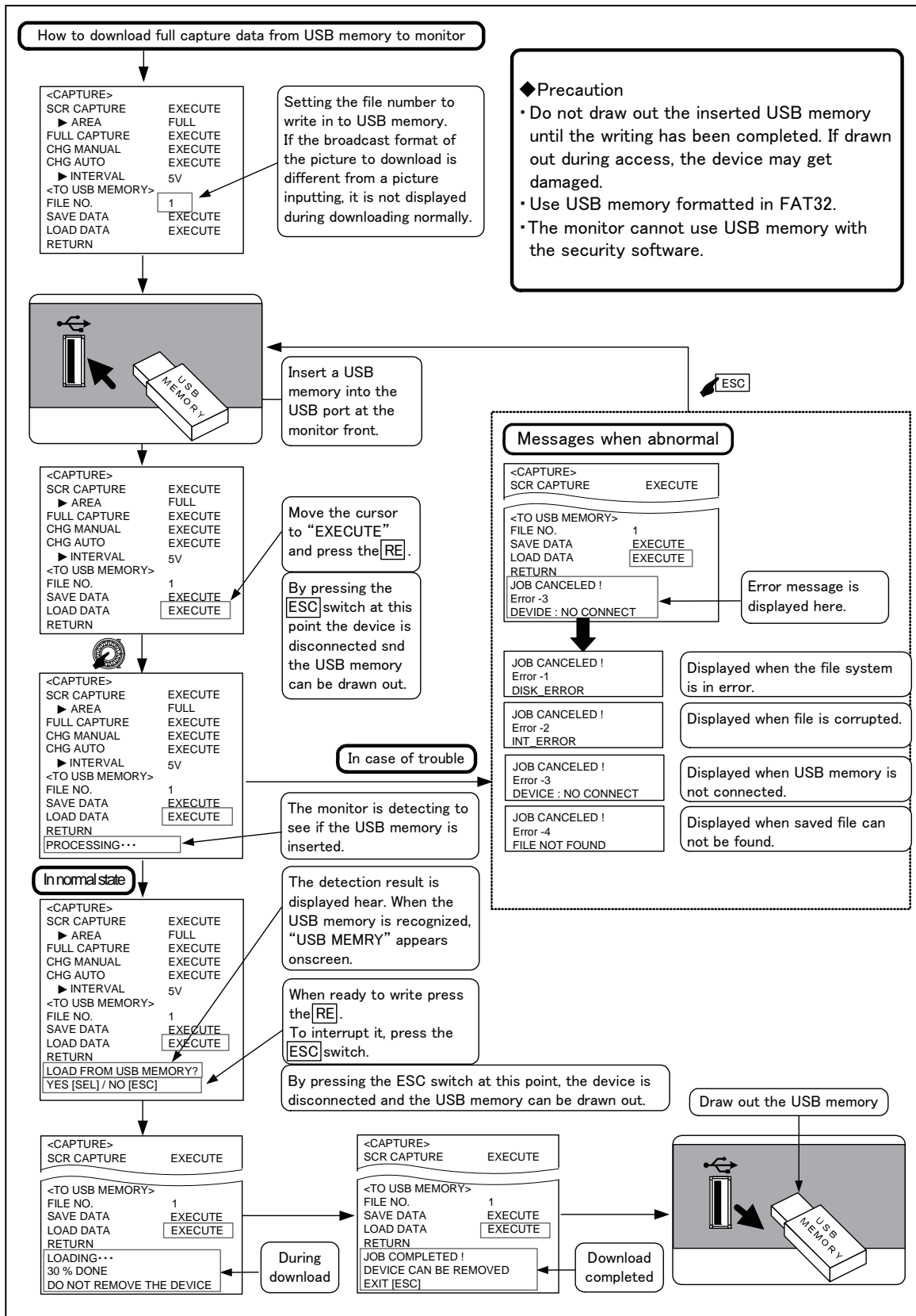

4-9. Description of MENU-UTILITY Functions

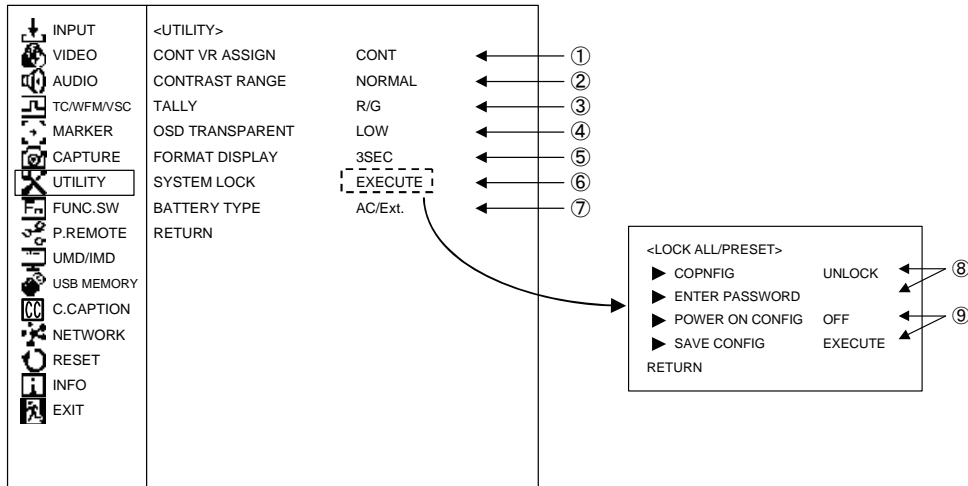

① Setting the CONT VR ASSIGN

- The "CONT" volume at the front can be operated for the purpose of backlight adjustment.
 - CONT : Operates for the purpose of CONTRAST adjustment
 - BL : Operates for the purpose of backlight adjustment
- This setting is reflected on the PRESET value.

• Default setting is CONT.

② Setting the CONTRAST RANGE

- NORMAL : Set the video level within the range with no over-flow even if the contrast level is MAX.
 - WIDE : The contrast level can be increased to two times.
- *High level video may saturate.

• Default setting is NORMAL.

③ Setting the TALLY

- Set any of the following display modes of the tally lamps located at the top of the front of the monitor.
- R/G : R is on the left side and G on the right side, when facing the screen.

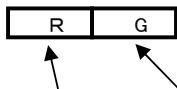

[R-TALLY ON] [G-TALLY ON]

- G/R : G is on the left side and R on the right side, when facing the screen.

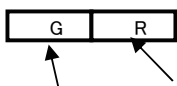

[G-TALLY ON] [R-TALLY ON]

- R+G : The entire tally is displayed.

The lamp is displayed in amber when both the R-TALLY and G-TALLY are set at ON. Both R- and G-TALLY at ON.

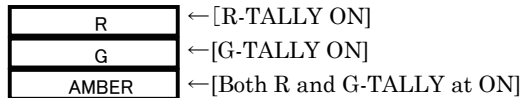

- R/G ALL : Displays the entire TALLY only when it is solely set to ON.

If both R-TALLY and G-TALLY are set to ON, they will be displayed on the left and right sides.

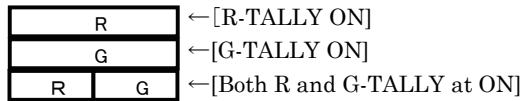

- G/R ALL : Displays the entire TALLY only when it is solely set to ON.

If both R-TALLY and G-TALLY are set to ON, they will be displayed on the left and right sides.

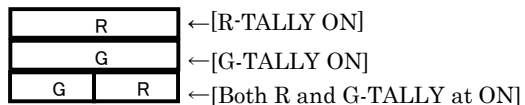

• Default setting is R/G.

④ Setting the OSD TRANSPARENCY

- The background for displaying the OSD can be set on 3 levels: LOW (semi-transparent) to HIGH (transparent).

• Default setting is LOW.

⑤ Setting the FORMAT DISPLAY

- Used to set whether the channel and signal format are displayed or not.
- 3SEC ON : Three seconds indication
- CONT ON : Continuous indication
- OFF : Indication off

FORMAT	FORMAT DISPLAY		
	VBS	SDI	HDMI
480i/59.94	480i/59.94	480i/59.94	480i/59.94
576i/50	576i/50	576i/50	576i/50
480p/59.94	—	—	480p/60
576p/50	—	—	576p/50
1035i/59.94	—	1035i/59.94	—
1035i/60	—	1035i/60	—
1080psF/23.98	—	1080i/47.96	1080i/48
1080psF/24	—	1080i/48	
1080psF/25	—	1080i/50	1080i/50
1080psF/29.97	—	1080i/59.94	1080i/60
1080psF/30	—	1080i/60	
720p/23.98	—	720p/23.98	720p/24
720p/24	—	720p/24	
720p/25	—	720p/25	720p/25
720p/29.97	—	720p/29.97	720p/30
720p/30	—	720p/30	
720p/50	—	720p/50	720p/50
720p/59.94	—	720p/59.94	720p/60
720p/60	—	720p/60	
1080p/23.98	—	1080p/23.98	1080p/24
1080p/24	—	1080p/24	
1080p/25	—	1080p/25	1080p/25
1080p/29.97	—	1080p/29.97	1080p/30
1080p/30	—	1080p/30	
1080p/50	—	1080p/50	1080p/50
1080p/59.94	—	1080p/59.94	1080p/60
1080p/60	—	1080p/60	

- Default setting is 3SEC ON.

⑥ Setting the SYSTEM LOCK

- Configure the data protection.
- For details, refer to "Function description of SYSTEM LOCK" in the section ⑧.

⑦ Setting the BATTERY TYPE

(HLM-960WR / 1760WR only)

- This function is used to set the voltage (discharge ending voltage) for warning that the battery is low. Select an appropriate mode according to the

nominal voltage of the battery to be used.

- AC/Ext. : AC or external stabilized DC power supply
- DC+14.8V : Battery with nominal voltage of 14.8V or 14.4V
- DC+13.2V : Battery with nominal voltage of 13.2V
- DC+12.0V : Battery with nominal voltage of 12.0V
- Default setting is AC/Ext.

Precautions for battery

- For the nominal voltage of the battery, refer to the indication on the battery or the instructions manual of the battery.
- For the following batteries, select DC +14.8V in the battery mode setting.
endura 9,9S by IDX CO., Ltd.
- When using a battery equipped with XLR 4-pin connector or when operating a battery using XLR 4-pin connector, make a proper selection in the battery setting according to the nominal voltage of the battery used.
Example: HP-90L by Paco Electronics Industry, Inc. : DC+13.2V
- When operated with the setting not in accordance with the battery's nominal voltage, the following events may result.
 - When nominal 13.2V battery is used with +DC12V setting.
Battery alarm, 30-second alarm and shutdown alarm will function. However, it may take longer from activation of the battery alarm until shutdown.
Also, the battery life may be adversely affected as the voltage is lower than the recommended discharge ending voltage.
 - When nominal 13.2V battery is used with +DC14.8V setting.
Service hours are shortened.
 - When nominal 12.0V battery is used with +DC14.8V setting.
Battery alarm and 30-second alarm may be triggered shortly even if fully charged battery is used, shutting down the monitor.
- If operation is stopped shortly despite correct battery mode setting (shutdown alarm will not flicker), it is likely that the battery's internal protection circuit has been activated.

⑧ Setting the SYSTEM LOCK

- How to set a password

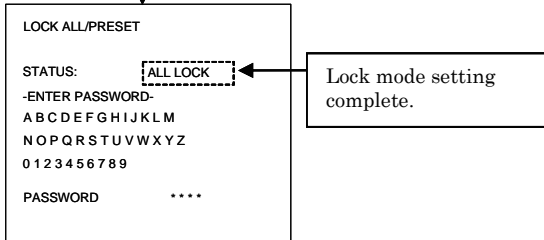
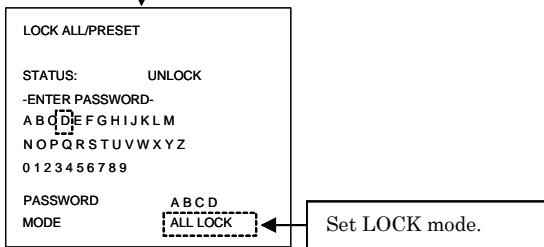
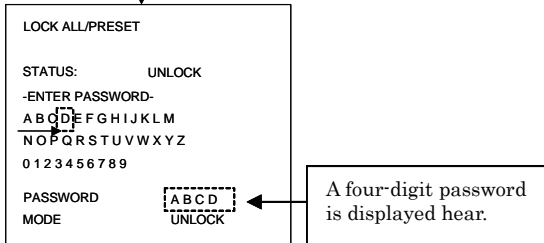
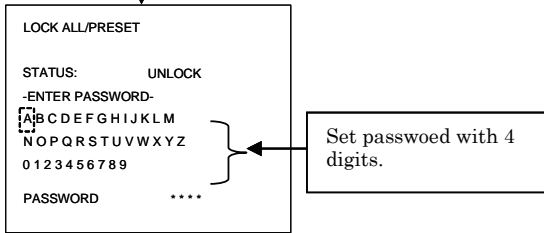
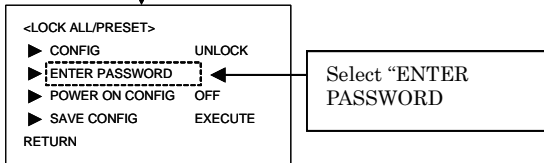
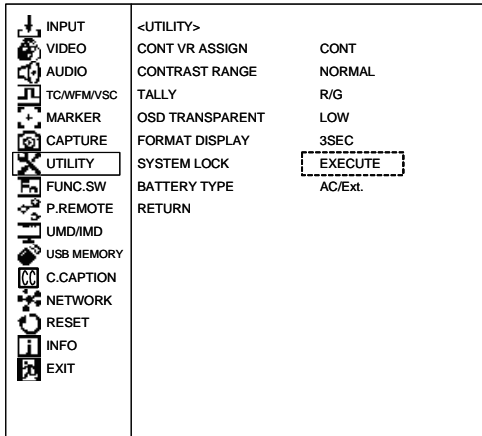

Contents of LOCK MODE

- UNLOCK : The lock is released and all data can be changed.
 - PRESET LOCK : The PRESET MENU setting of item 5 is locked.
 - ALL LOCK : In addition to the PRESET MENU lock, the MENU setting is also locked.
- * When "POWER ON CONFIG" is set to "ON", setting the LOCK MODE is not possible.
 * FUNCTION switch assignments, functions related to MENU setting and PRESET MENU setting are locked.

⑨ Setting the POWER ON CONFIG

- The items to be stored in "POWER ON CONFIG" are executed here.
- When the "SAVE CONGIG" is executed, the setting items for the MENU and PRESET MENU are stored (except some of the following items). If the power is turned on with the "POWER ON CONFIG: ON" setting, all items that are stored here will be loaded.
- POWER ON ONFIG memory method

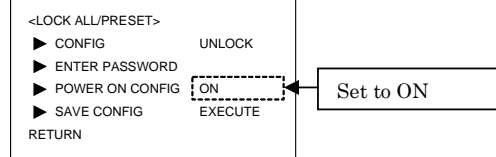
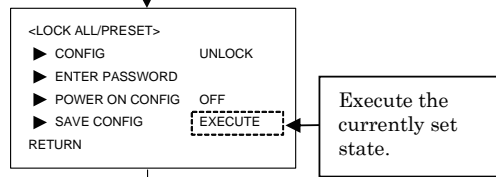
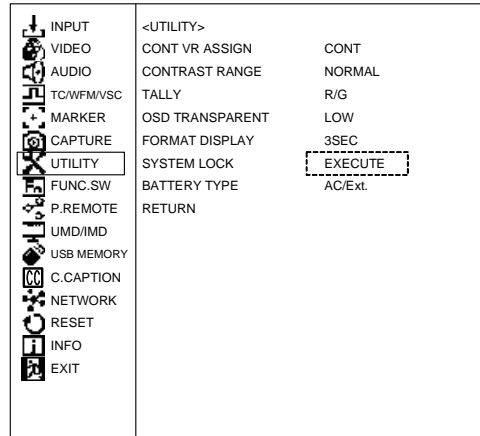

- * The items that will not be stored in POWER ON CONFIG.
- User marker setting value
- The setting values of "H POSITION" and "V POSITION" .

4-10. Description of MENU-FUNC.SW Functions

INPUT	<FUNC.SW>		
VIDEO	FUNCTION1 MODE	WFM ON	← ①
AUDIO	FUNCTION2 MODE	VITC ON	← ②
TC/WFM/VSC	FUNCTION3 MODE	MIX TEST	← ③
MARKER	FUNCTION4 MODE	VSC ON	← ④
CAPTURE	RETURN		
UTILITY			
F1	FUNC.SW		
P.REMOTE			
UMD/IMD			
USB MEMORY			
C.CAPTION			
NETWORK			
RESET			
INFO			
EXIT			

F1 to F4 SW Function Assignment List

The available functions which can be assigned for each function switch are as follows:

- CHR UP Switching of the ON/OFF of CHROMA UP
CHROMA UP ON → OFF →
- FILE Switching of the PRESET FILE
D65 → D93 → FILE1 → FILE2... →
- SCAN Switching of the NORMAL/UNDER SCAN
UNDER SCAN → NORMAL SCAN →
- ASPECT Switching of 4:3 and 16:9 for SD signals
ASPECT 4:3 → 16:9 →
- REAL SCAN Switching of the REAL/NORMAL SCAN
REAL SCAL → NORMAL SCAN →
- MRK SEL Switching of the type of MARKER
SAFETY → CROSS 5... → ASP+SAF →
- C.MRK ON Switching of the ON/OFF of CENTER MARKER
TYPE-A → TYPE-B → OFF →
- UMRK ON Switching of the ON/OFF of USER MARKER
USER MARKER ON → OFF →
- UMRK SEL Switching of the scenes of USER MARKER
SCENE1 → 2 → 3... → 10 → OFF →
- DELAY Switching of the H/V/H+V of DELAY
Enabled only for SDI input
H.DL → V.DL → H/V.DL → DL OFF
- FCAP Capturing of full-screen images
Shortcut key to the Image Capture Menu
* This function does not work in ALL LOCK mode.
- MEM MNU Manual switching of a full capture image and the input signal image
Shortcut key to the Execution Menu
- MEM AUTO Automatic switching of a full capture image and the input signal image
Shortcut key to the Execution Menu
* It will not operate unless the image is captured in advance.
* This function does not work in ALL LOCK mode.
- COMB Switching of the Decoder Y/C separation setting
COMB → TRAP →
- AUD CH Switching of the embedded audio channel
CH1/2 → CH3/4 → CH5/6 → CH7/8 → DMIX →
- BL DIM Increases the backlight brightness.
1 → 2 → 3 → 4 → 5 → 6 → . . . 29 → 30 →
* This function does not work in PRE-SET LOCK and ALL LOCK mode.
- MIX TEST Switching of the ON/OFF of MIX TEST SIGNAL
MIX TEST SIGNAL ON → OFF
- PinP ON Switching of the ON/OFF of PinP
PinP ON → OFF →
- WFM ON Switching of the ON/OFF of WFM
WFM ON → OFF →
- TC ON Switching of the ON/OFF of SDI TC
TC ON(VITC/LTC) → OFF →
- VSC ON Switching of the ON/OFF of VECTOR
VSC ON → OFF →
- WB A shortcut key to the PRESET MENU for white balance adjustment.
* This function does not work in PRE-SET LOCK and ALL LOCK modes.
- APT ON Switching of the ON/OFF of APT
APT ON → OFF →

- * "DELAY" DELAY corresponds to SDI signal only.
During the DELAY, it will be the same magnification display (REAL SCAN) so that the scaling process is not performed.
- * "SCREEN" function can be assigned only to HLM - 960WR / WCS models.

① Setting the function assignment of the **F1 switch**

- The function assignment is selectable from the list shown above ①. Then the assigned function is controlled by pressing the **F1** switch on the front panel.
- Default setting is VITC OFF.

② Setting the function assignment of the **F2 switch**

- The function assignment is selectable in the same way as described above.
- Default setting is VITC OFF.

③ Setting the function assignment of the **F3 switch**

- The function assignment is selectable in the same way as described above.
- Default setting is MIX TEST.

④ Setting the function assignment of the **F4 switch**

- The function assignment is selectable in the same way as described above.
- Default setting is VSC ON.

4-11. Description of MENU-P.REMOTE Functions

	<P.REMOTE>	
	PIN FUNCTION	DEFAULT
	P2 :	CH-B
	P3 :	(blank)
	P4 :	G-TALLY
	P5 :	(blank)
	P6 :	CHROMA UP
	P7 :	MONO
	P8 :	(blank)
	P9 :	(blank)
	P10:	ASPECT
	P11:	(blank)
	P12:	MARKER
	P13:	SHADOW
	P14:	R-TALLY
	P15:	SDI
RETURN		

① Setting the functions of the parallel remote pins

- Select the pre-assigned pin functions of the parallel remote control or the individual user-set functions.
- * By default, the pre-assigned pin functions are displayed beneath.

② Setting the IP conversion mode

- When “USER” is selected in ①, set the individual pin functions. The available functions are as follows.
 - CH-B : selection of SDI CH-A/B
At this time, also set the "SDI" terminal to ON (GND).
 - CH-C : selection of SDI CH-A/C
(When CH-C is set for input)
At this time, also set the "SDI" terminal to ON (GND).
 - CH-D : selection of SDI CH-A/D
(When CH-D is set for input)
At this time, also set the "SDI" terminal to ON (GND).
 - SDI : selection of SDI input
 - HDMI : selection of HDMI input
 - MONO : selection of MONO
 - 16:9 : selection of SDTV aspect ratio 16:9
 - MARKER : marker ON
 - SHADOW : shadow ON at the level set in **MENU-MARKER-SHADOW**

- SHADOW0 : shadow ON at shadow level 0% (Black)
- SHADOW20 : shadow ON at shadow level 20%
- SHADOW40 : shadow ON at shadow level 40%
- SHADOW60 : shadow ON at shadow level 60%
- R-TALLY : R tally ON
- G-TALLY : G tally ON
- CHR UP : CHROMA UP ON
- UMARK* : USER MARKER SCENE* ON
- PinP : PinP ON
- (blank) : unassigned

- * “SHADOW0 ” , “SHADOW20 ” , “SHADOW40 ” and “SHADOW60 ” functions
- Select two or more SHADOW settings at once, and “SHADOW0” (Black) is given priority.
- When any of these functions is turned ON, the **MENU-MARKER**-adjusted shadow level is forced to go back to the level remotely preset.
- * The functions of the following pins, which are fixed, cannot be changed.
 - Pin 1 : GND

4-12. Description of MENU-UMD/IMD Functions

* HLM-2460W does not have the DISPLAY POSITION setting.

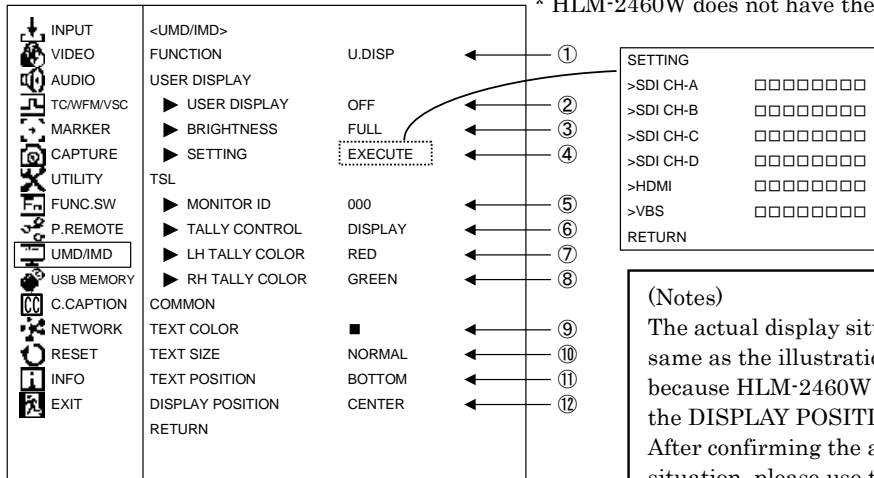

(Notes)
The actual display situations may not be same as the illustrations in this section, because HLM-2460W does not have the DISPLAY POSITION setting. After confirming the actual display situation, please use this function.

① Setting the TSL/USER DISPLAY function switching

- Selects whether the UMD/IMD display is performed by TSL or DISPLAY.
 - TSL: TSL is enabled
 - U.DISP: USER DISPLAY is enabled
- Default setting is U.DISP.

SETTING	
>SDI CH-A	□□□□□□□□
>SDI CH-B	□□□□□□□□
>SDI CH-C	□□□□□□□□
>SDI CH-D	□□□□□□□□
>HDMI	□□□□□□□□
>VBS	□□□□□□□□
RETURN	

② Setting the USER DISPLAY ON/OFF

- Selects whether the USER DISPLAY characters set in section ④ are displayed on the screen or not..
 - ON: Displays on the screen
 - OFF: Does not display
- When 2 screen display is selected, the characters set in ④ are displayed.

- Here you can set 8 characters to be displayed on the screen when switching each input channel.
- Character types

A B C D E F G H I J K L M N O P Q R S T U
V W X Y Z 0 1 2 3 4 5 6 7 8 9 - () [blank]

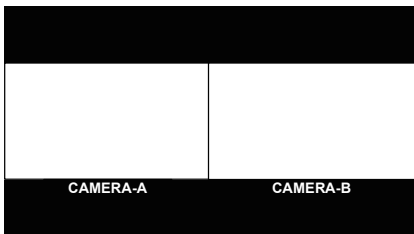

- Default setting is ON.

⑤ Setting the TSL monitor ID number

- Here you can set each monitor ID number for controlling the TSL using RS485.
- The ID number can be set between 0 and 126.
- Although the maximum number of devices that can be driven with chain connection is 32 devices per line, you can individually control up to 126 devices by increasing the number of lines.
- Default setting is 000.

③ Setting the USER DISPLAY character brightness

- Sets the brightness of characters that are displayed on the screen.
 - FULL: 100% brightness
 - 1/2: 50% brightness
 - 1/7: 30% brightness
- Default setting is FULL.

⑥ Setting the TSL TALLY light-up method

- Sets whether to light up the TALLY set on the top of monitor or display it on the screen.
 - DISPLAY: Displays on the screen
 - LED: LED lights up.
- Default setting is DISPLAY

④ Setting the USER DISPLAY character content

- When "EXECUTE" is performed, the following MENU is displayed, then you can set the character contents.

<TALLY lights up when it is set to LED>

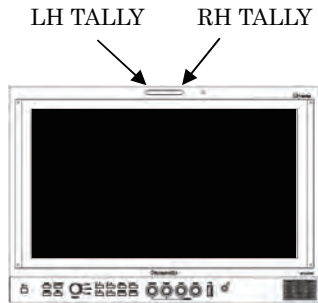

<TALLY is displayed when it is set to DISPLAY>

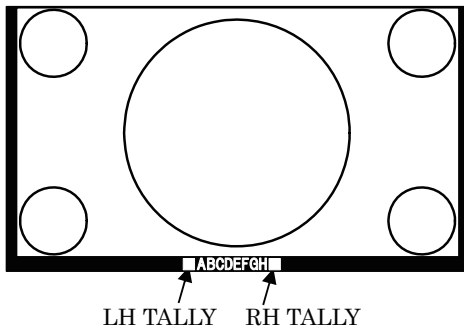

⑦ Setting the TSL TALLY (left side) color

- Selects the display color for the TALLY (left side) from three colors: "RED/GREEN/AMBER".
- Default setting is RED

⑧ Setting the TSL TALLY (right side) color

- Selects the display color for the TALLY (right side) from three colors: "RED/GREEN/AMBER".
- Default setting is GREEN

⑨ Setting the Display character color (common setting item)

- Selects the character color from seven colors: "WHITE/YELLOW/CYAN/GREEN/MAGENT/RED/BLUE".
- Default setting is WHITE

⑩ Setting the Display character size (common setting item)

- Selects the character size from two types: "NORMAL/SMALL".
- NORMAL: Character size, large
- SMALL: Character size, small
- Default setting is NORMAL

⑪ Setting the Display character position (common setting item)

- Selects the character position from two types:
 - BOTTOM: Displays on the bottom of screen
 - TOP: Displays on the top of screen
- Default setting is BOTTOM

⑫ Setting the Video display position (common setting item)

- Selects the video display position from two types:
 - CENTER : Always displays the video on the center of screen
 - AUTO : Automatically sets the image on the top or bottom depending on the TOP/BOTTOM setting in the TEXT
- The display character is forcibly set to "SMALL".

- Default setting is CENTER

* HLM-2460W does not have this setting.

UMD / IMD Indication Table

* HLM-2460W does not have the DISPLAY POSITION setting.

TEXT SIZE : NORMAL
 TEXT POSITION : BOTTOM
 DISPLAY POSITION : CENTER

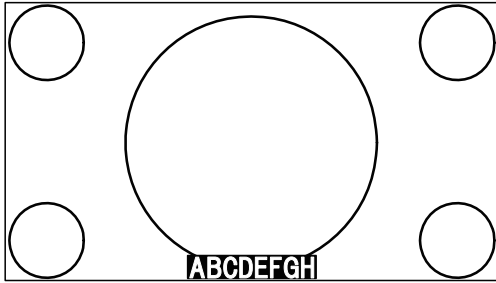

TEXT SIZE : NORMAL
 TEXT POSITION : TOP
 DISPLAY POSITION : CENTER

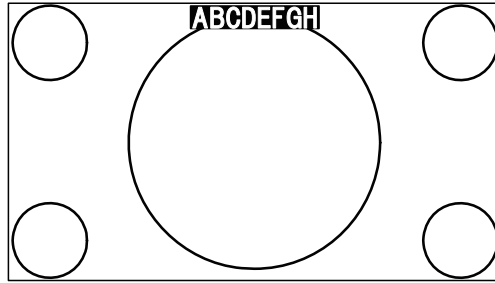

TEXT SIZE : SMALL
 TEXT POSITION : BOTTOM
 DISPLAY POSITION : CENTER

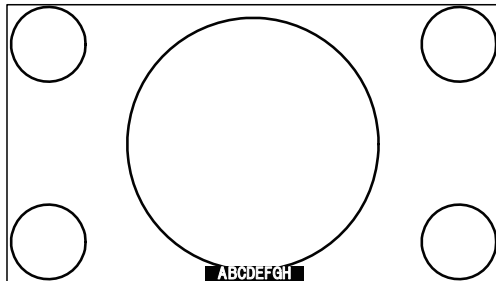

TEXT SIZE : SMALL
 TEXT POSITION : TOP
 DISPLAY POSITION : CENTER

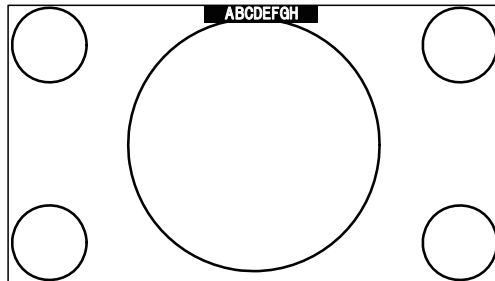

TEXT SIZE : NORMAL
 TEXT POSITION : BOTTOM
 DISPLAY POSITION : AUTO

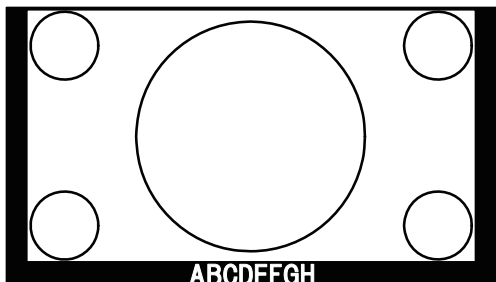

TEXT SIZE : NORMAL
 TEXT POSITION : TOP
 DISPLAY POSITION : AUTO

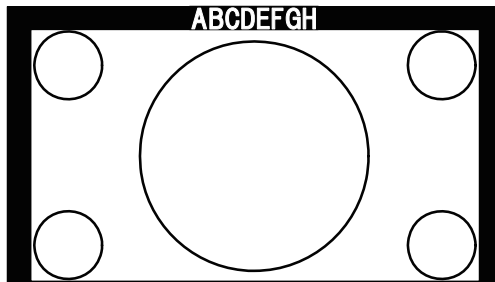

TEXT SIZE : SMALL
 TEXT POSITION : BOTTOM
 DISPLAY POSITION : AUTO

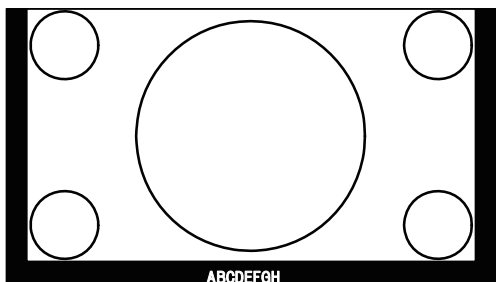

TEXT SIZE : SMALL
 TEXT POSITION : TOP
 DISPLAY POSITION : AUTO

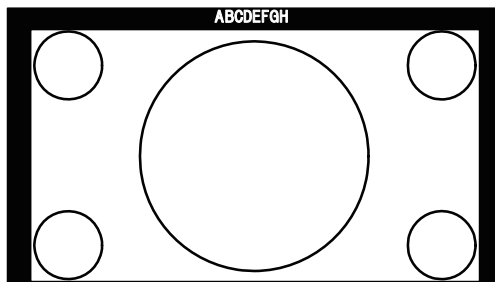

4-13. Description of MENU-USB MEMORY Functions

INPUT	<USB MEMORY>		
VIDEO	SETTING DATE&TIME		
AUDIO	▶ DATE(Y/M/D)	17 / 01 / 01	①
TC/WFM/VSC	▶ TIME(H:M)	00:00	②
MARKER	CONFIG		
CAPTURE	▶ MENU&SW	<input type="checkbox"/>	③
UTILITY	▶ USER MARKER	<input type="checkbox"/>	④
FUNC.SW	▶ PRESET	<input type="checkbox"/>	⑤
P.REMOTE	SAVE CONFIG	EXECUTE	⑥
UMD/IMD	LOAD CONFIG	EXECUTE	⑦
USB MEMORY	UP DATE		
C.CAPTION	▶ MPU FIRMWARE	<input type="checkbox"/>	⑧
NETWORK	▶ FPGA	<input type="checkbox"/>	⑨
RESET	▶ UP DATE	EXECUTE	⑩
INFO	RETURN		
EXIT			

Writing from monitor to USB memory

① Setting the date of a file to be written on USB memory

- Used to set the editing date of a file to be written on a USB memory. Enter a date when you are going to write on the USB memory. When reviewing files on a computer, the date entered here will be displayed as the date of the file.
- Enter “Y (year)/M (month)/D (day)” in this order.
- If no date is entered, the file will be edited as of the date appearing currently in the menu.

② Setting the time of a file to be written on USB memory

- Used to set the editing time of a file in a way similar to Item ① .
- Enter “H (hour) : M (minute)” in this order. If no time is entered, the file will be edited as of the time appearing currently in the menu.

③—⑥ Writing to USB memory

- To write all the setting data from the monitor to a USB memory, select “EXECUTE” and press the **RE**. For writing details, refer to “How to write from monitor to USB memory” .
- **File format for writing to USB memory**
Files to be written from the monitor to a USB memory are created in the following 3 text files.

File structure

MENUSW.TXT

- File to save the menu (USER MARKER and PRESET MENU not included) status and the switch settings.
- Data capacity: Approx. 6 Kbyte
- Since this is a model-specific file, you cannot download the data that was stored with a different model or vice versa.

UMARK01.TXT (for SCENE1)
UMARK02.TXT (for SCENE2)

UMARK10.TXT (for SCENE10)

- File to save various setting data of the user markers that are preset in **MENU-MARKER**.
- Data capacity: Approx. 2 Kbyte (per scene)

PRECTL.TXT (for PRESETcontrol)
PRED65.TXT (for D65)
PRED93.TXT (for D93)
PREFILE1.TXT (for FILE1)
PREFILE2.TXT (for FILE2)
PREFILE3.TXT (for FILE3)
PREFILE4.TXT (for FILE4)
PREFILE5.TXT (for FILE5)
PREFILE6.TXT (for FILE6)
PREFILE7.TXT (for FILE7)
PREFILE8.TXT (for FILE8)

- File to save the PRESET menu settings as well as all the D65, D93 and FILE1 thru -8 data.
The password lock and the password itself are not saved, however.
- Data capacity: Approx. 1 Kbyte (per file)
The PRESET data of other models cannot be downloaded.

◆Precautions on writing

- With a USB connected to the monitor, do not turn ON/OFF the monitor or disconnect the inserted USB memory while writing is going on, or else the USB memory may possibly be damaged. Be sure to disconnect the USB memory in accordance with the procedure described under “How to write from monitor to USB memory”.
- Do not change the name of an automatically generated folder or a file, or else downloading to the monitor will be disabled. Do not modify the data in a file, or else the order of the data may be altered, disabling writing of the data.
- If there is a file already in the specified folder, the data of a new file will be overwritten on the existing file.
- High-security USB memories may not be recognized.
- There are some types of USB memory can not be recognized, please use another USB memory if not recognized.

Downloading from USB memory to monitor

③—⑤ Selecting items to be downloaded

- Select the items of data to be downloaded from the USB memory to the monitor. Tick the check box.
- Contents of individual items
 - a) MENU&SW
 - Tick this check box to download the setting status of all the menus (excluding USER MARKER MENU and PRESET MENU) and the switch setting status.
 - The following files are dedicated to each model and loaded as model-specific files.
“¥MENU&SW.TXT”
 - * Since this is a model-specific file, you cannot download data that was stored with a different model.

b) USER MARKER

- Check this box if you want to download the various settings (color, ON/OFF, XY coordinates) of “S01 (SCENE1) to S10 (SCENE10)” that were set in the **MENU-MERKER -USER MARKER**.
- The files for each scene of “UMARK01.TXT” to “UMERK10.TXT” will be downloaded.
- * Since this is a model-specific file, you cannot download data that was stored with a different model.

c) PRESET

- To download the items set on the PRESET MENU and all of the data of D65, D93, and FILE 1 ~ 8, tick this check box.
- * If the data is locked with a password, you cannot check the box. Please enter the password and unlock it before downloading.
- * Since this is a model-specific file, you cannot download data that was stored with a different model.
- * It is possible to download the file from the same model. However, the color temperature data stored in the FILE is different for each device; therefore the same color temperature cannot be achieved even if you download the data. For this reason, the PRESET data should be downloaded for the purpose of data backup on each monitor.

⑦ Executing the downloading

- To download the data of the items selected under Item ④ from the USB memory to the monitor, press **RE** under “EXECUTE.”
Refer to “How to download from USB memory to monitor” for the details of writing.
- If the file specified under Item ④ does not exist in the specific folder of the USB memory, a warning message will appear.

◆ Precautions on downloading

- With a USB memory connected to the monitor, do not turn ON/OFF the monitor or disconnect the inserted USB memory while downloading is going on, or else the USB memory may possibly be damaged. Be sure to disconnect the USB memory in accordance with the procedure described under "How to download from USB memory to monitor".
- Do not change the name of an automatically generated folder or a file, or else downloading to the monitor will be disabled. Do not modify the data in a file, or else the order of the data may be altered, disabling writing of the data.
- If a data in the monitor is locked with a password, "PRESET LOCK" or "ALL LOCK" will appear on the MENU as shown on the diagram below.
Enter the password to unlock the data first and then download the data.
- It is possible in some cases that a high-security USB memory may not be recognized by the monitor.

◆ Error messages during writing or downloading

ERROR-1	A file system error is detected
ERROR-2	USB memory is broken.
ERROR-3	USB memory is not connected
ERROR-4	File is not found
ERROR-4~	Various errors on access

How to write from monitor to USB memory

```

<-USB MEMORY>
SETTING DATE&TIME
▶ DATE(Y/M/D) 17 / 01 / 01
▶ TIME(H:M) 00 : 00
CONFIG
▶ MENU&SW
▶ USER MARKER
▶ PRESET
SAVE CONFIG EXECUTE
LOAD CONFIG EXECUTE
UP DATE
▶ MPU FIRMWARE
▶ FPGA
▶ UP DATE EXECUTE
RETURN
    
```

Enter the data and time of a file to be written on a USB memory.
 *If no data and time is entered here, the already entered setting will be upheld.
 Tick the check box (☐) for items to write from the monitor to a USB memory.

◆Precaution

- Do not draw out the inserted USB memory until the writing has been completed. If drawn out during access, the device may get damaged.
- Use USB memory formatted in FAT32.
- The monitor cannot use USB memory with the security software.

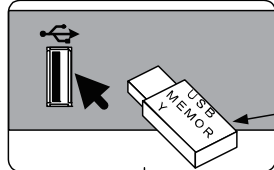

Insert a USB memory into the USB port at the monitor front.

```

<-USB MEMORY>
SETTING DATE&TIME
▶ DATE(Y/M/D) 17 / 01 / 01
▶ TIME(H:M) 00 : 00
CONFIG
▶ MENU&SW
▶ USER MARKER
▶ PRESET
SAVE CONFIG EXECUTE
LOAD CONFIG EXECUTE
RETURN
    
```

Move the cursor to "EXECUTE" and press the [RE].
 By pressing the [ESC] switch at this point the device is disconnected and the USB memory can be drawn out.

Messages when abnormal

```

<-USB MEMORY>
SETTING DATE&TIME
▶ DATE(Y/M/D) 17 / 01 / 01
▶ TIME(H:M) 00 : 00
CONFIG
▶ MENU&SW
▶ USER MARKER
▶ PRESET
SAVE CONFIG EXECUTE
LOAD CONFIG EXECUTE
RETURN
JOB CANCELED !
Error -3
DEVICE : NO CONNECT
    
```

Error message is displayed here.

- JOB CANCELED ! Error -1 DISK_ERROR: Displayed when the file system is in error.
- JOB CANCELED ! Error -2 INT_ERROR: Displayed when file is corrupted.
- JOB CANCELED ! Error -3 DEVICE : NO CONNECT: Displayed when USB memory is not connected.
- JOB CANCELED ! Error -4 FILE NOT FOUND: Displayed when saved file can not be found.

```

<-USB MEMORY>
SETTING DATE&TIME
▶ DATE(Y/M/D) 17 / 01 / 01
▶ TIME(H:M) 00 : 00
CONFIG
▶ MENU&SW
▶ USER MARKER
▶ PRESET
SAVE CONFIG EXECUTE
LOAD CONFIG EXECUTE
RETURN
[PROCESSING...]
    
```

In case of trouble
 The monitor is detecting to see if the USB memory is inserted.

In normal state

```

<-USB MEMORY>
SETTING DATE&TIME
▶ DATE(Y/M/D) 17 / 01 / 01
▶ TIME(H:M) 00 : 00
CONFIG
▶ MENU&SW
▶ USER MARKER
▶ PRESET
SAVE CONFIG EXECUTE
LOAD CONFIG EXECUTE
RETURN
SAVE TO USB MEMORY?
YES [SEL] / NO [ESC]
    
```

The detection result is displayed here. When the USB memory is recognized, "USB MEMRY" appears onscreen.
 When ready to write press the [RE].
 To interrupt it, press the [ESC] switch.
 By pressing the [ESC] switch at this point, the device is disconnected and the USB memory can be drawn out.

```

<-USB MEMORY>
SETTING DATE&TIME
▶ DATE(Y/M/D) 17 / 01 / 01
▶ TIME(H:M) 00 : 00
CONFIG
▶ MENU&SW
▶ USER MARKER
▶ PRESET
SAVE CONFIG EXECUTE
LOAD CONFIG EXECUTE
RETURN
SAVING...
DO NOT REMOVE THE DEVICE
    
```

During write

```

<-USB MEMORY>
SETTING DATE&TIME
▶ DATE(Y/M/D) 17 / 01 / 01
▶ TIME(H:M) 00 : 00
CONFIG
▶ MENU&SW
▶ USER MARKER
▶ PRESET
SAVE CONFIG EXECUTE
LOAD CONFIG EXECUTE
RETURN
JOB COMPLETED !
DEVICE CAN BE REMOVED
EXIT [ESC]
    
```

Write complete

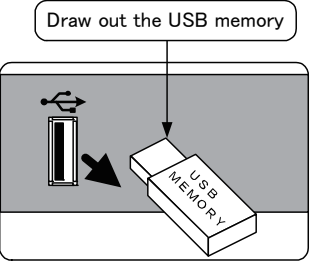

Draw out the USB memory

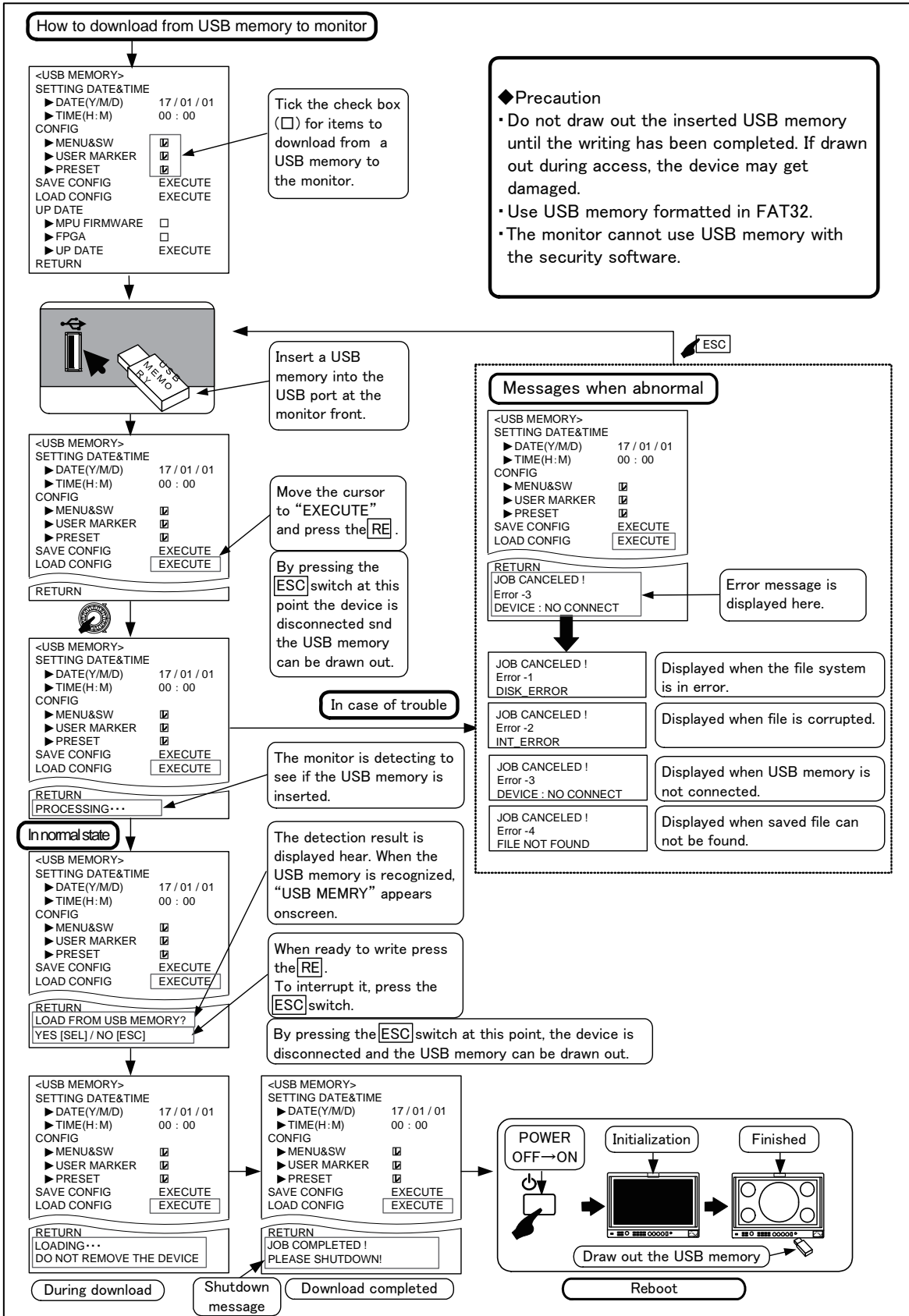

⑧ **MPU FIRMWARE**

- When updating the MPU firmware, tick the check box here.
- It can be updated simultaneously with FPGA.
- The update time depends on USB performance. It takes approximately 0.5 minutes to 1 minute to update the MPU.
- Make sure that the following files are in the root of the USB memory and follow the procedure in item ⑩.
- After update, check whether version update was done at **MENU-INFO**.

<p>FILE NAME : 1760v□□□ . bin</p> <p style="text-align: center;">① ② ③</p> <p>①Identification information HLM-960WR : 960_v HLM-1760WR : 1760v HLM-2460WR : 2460v</p> <p>②Version information Example : 1760v105.bin → Ver1.05</p>

⑩ **Execution of download**

- Execute the updating of the item or items selected by ticking under item ①.
- Please refer to “How to update MPU from USB memory” for the method of updating MPU.
- Please refer to “How to update FPGA from USB memory” for the method of updating FPGA.
- When updating both MPU and FPGA simultaneously, the monitor will update the FPGA first, and even if an error should occur, then update the MPU next.

⑨ **FPGA FIRMWARE**

- When updating the FPGA, tick the check box here.
- It can be updated simultaneously with MPU.
- The update time depends on USB performance. It takes approximately 2 minutes to 4 minutes to update the FPGA.
- Make sure that the following files are in the root of the USB memory and follow the procedure in item ⑩.
- After version update, check whether version update was done at **MENU-INFO**.

<p>FILE NAME : 60 __ f □□□ . f1b</p> <p style="text-align: center;">① ② ③</p> <p>①Identification information (fixed to 60__f) ②Version information Example : 60__f105 → Ver1.05</p> <p>③Extension (f1b)</p>

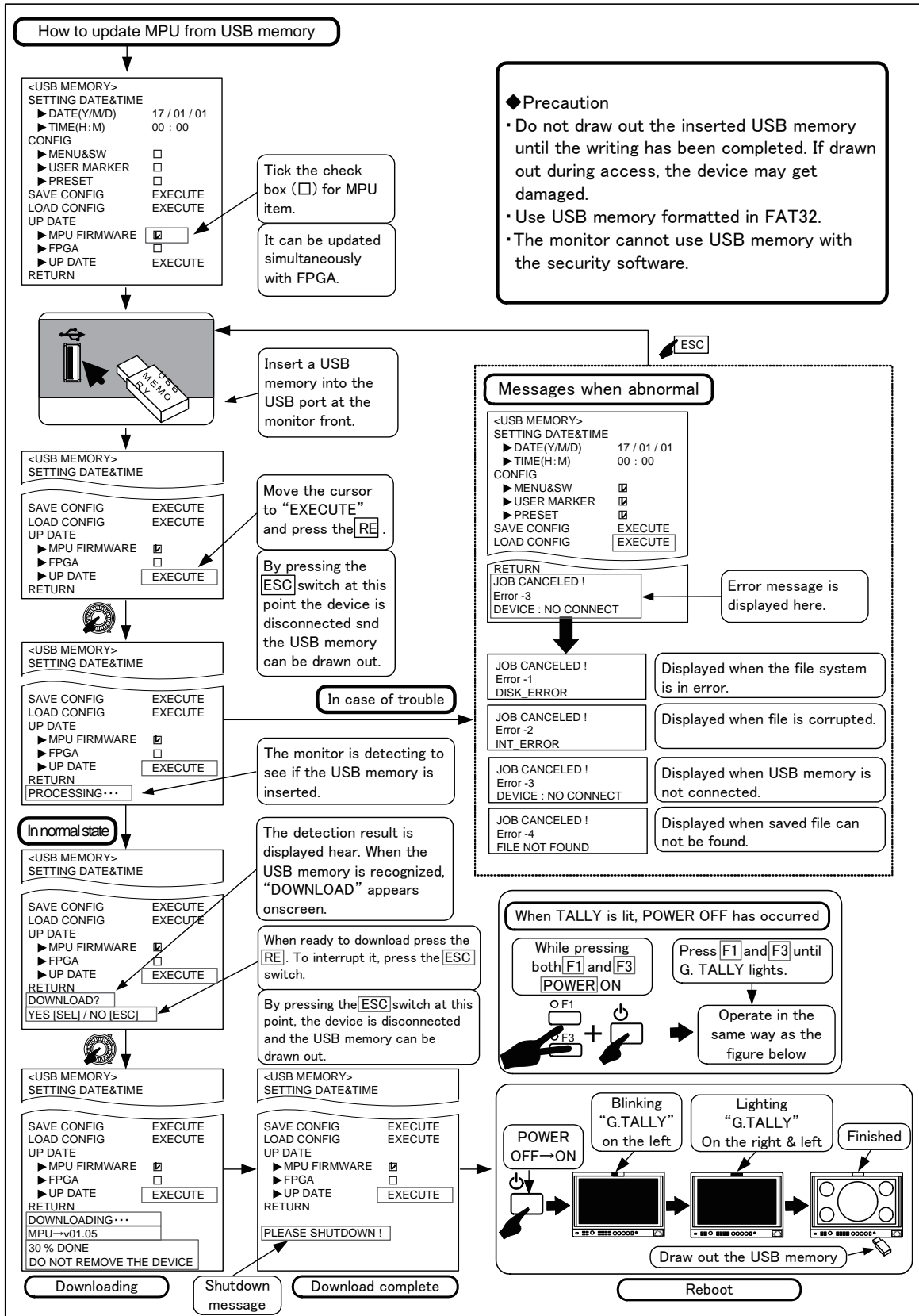

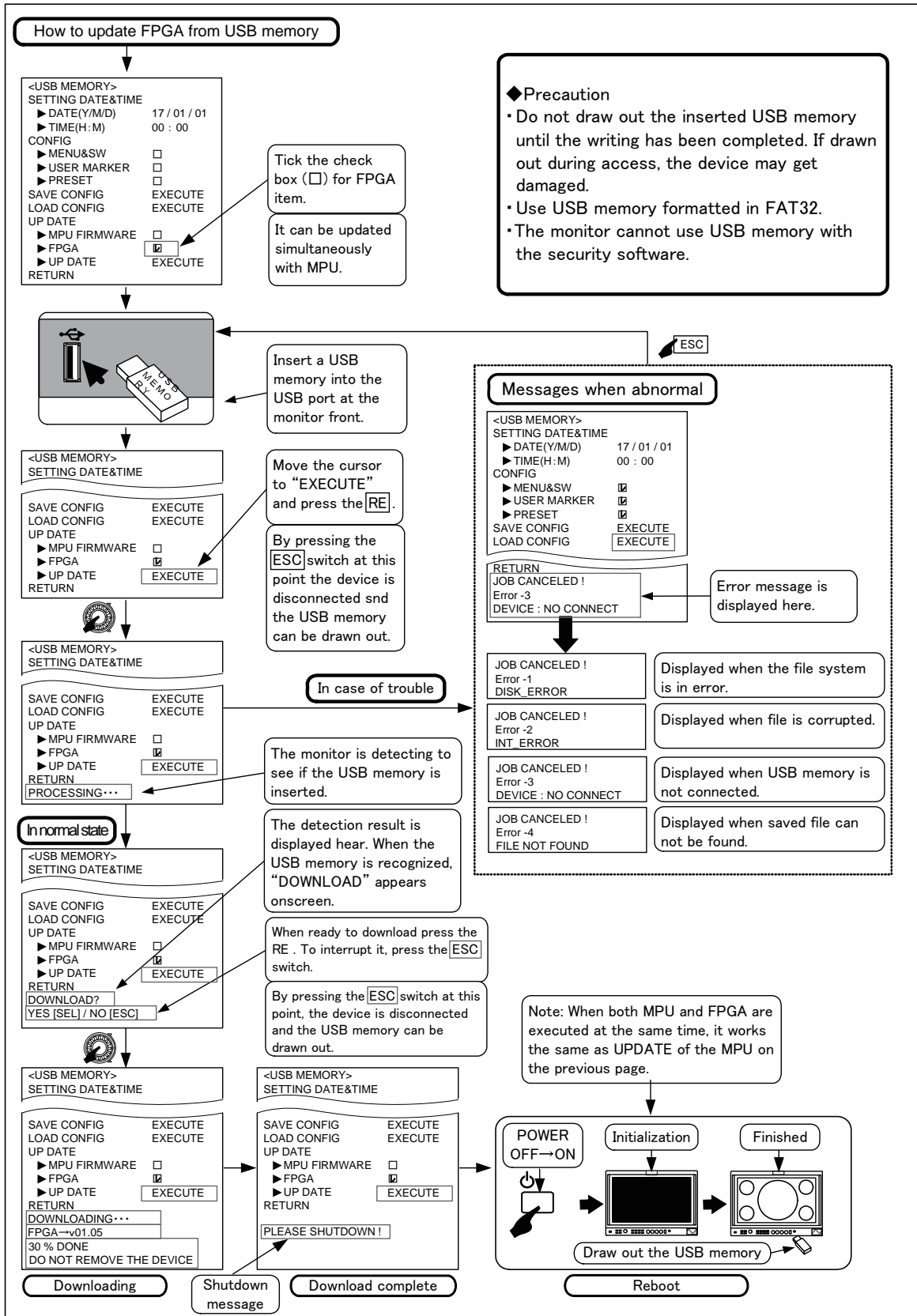

4-14. Description of MENU-C.CAPTION Functions

INPUT	<C.CAPTION>		
VIDEO	CLOSED CAPTION	OFF	① ←
AUDIO	HD TYPE	708	② ←
TC/WFM/VSC	SD TYPE	608 / ANC	③ ←
MARKER	SERVICE(708)	#1	④ ←
CAPTURE	SERVICE(608)	CC1	⑤ ←
UTILITY	C.CAPTION LEVEL	HIGH	⑥ ←
FUNC.SW	RETURN		
P.REMOTE			
UMD/IMD			
USB MEMORY			
C.CAPTION			
NETWORK			
RESET			
INFO			
EXIT			

① Closed Caption ON/OFF Setting

- Setting ON/OFF for Closed Caption.
- Default setting is OFF.

※Closed Caption is not displayed while menu, mouse menu or preset is opened or when any input signals except SDI are selected.

② Setting type of Closed Caption in HD-SDI signal

- 708 : To be selected to display 708 in HD-SDI signal.
- 608/708 : To be selected to display 608/708 in HD-SDI signal.
- Default setting is 708.

※708 is Closed Caption signal based on EIA/CEA-708 standard.

608/708 is Closed Caption signal based on EIA/CEA-608 standard, being transmitted by EIA/CEA-708 standard.

③ Setting type of Closed Caption in SD-SDI signal

- 608/ANC : To be selected to display 608/ANC in SD-SDI signal.
- 608/VBI : To be selected to display 608/VBI in SD-SDI signal.
- Default setting is 608/ANC.

※608/ANC is Closed Caption signal based on EIA/CEA-608 standard.

※608/VBI is Closed Caption signal based on

EIA/CEA-608 standard, being transmitted on 21 lines.

④ Setting for display caption in HD type

- To be selected among SERVICE #1 to #6.
- Default setting is #1.

⑤ Setting for display caption in SD type

- To be selected among CC1 to CC4 or TEXT1 to TEXT4.
- Default setting is CC1.

⑥ Setting brightness for Closed Caption

- Setting brightness for Closed Caption. To be selected between HIGH and LOW.
- Default setting is HIGH.

Notice: There are cases where the closed caption can not be displayed correctly, when the input signal is switched. When the setting of ② is 608/708, there is the limitation item like below:

TYPE	Format	Limitation item
HD TYPE	1080p/60	Unsupport
	720p/60	TEXT1~TEXT4 of SERVICE(608)
	1080i/60	
SD TYPE	480i/59.94	None

4-15. Description of MENU-NETWORK Functions

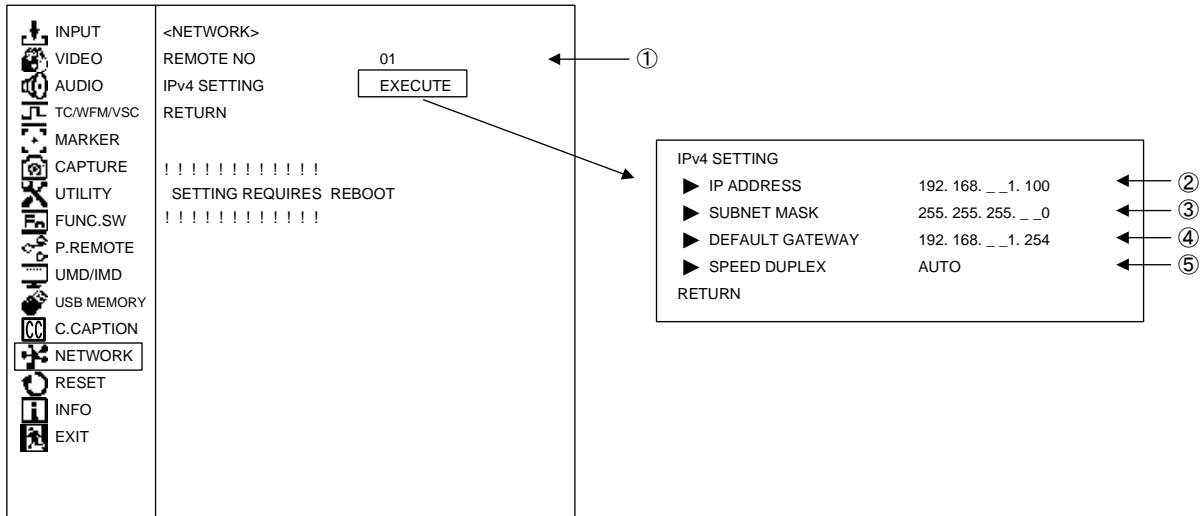

① REMOTE NUMBER

Set the ID number within the range from 01 to 99 when remote control is performed on a network.

- Default setting is 01.

② IP ADDRESS

- Set the IP ADDRESS.
- Setting range: 0 ~ 255. 0 ~ 255. 0~255. 1~254

③ SUBNET MASK

- Set the SUBNET MASK.
- Setting range: 0 ~ 255. 0 ~ 255. 0~255. 0~255

④ DEFAULT GATEWAY

- Set the DEFAULT GATEWAY.
- Setting range: 0 ~ 255. 0 ~ 255. 0~255. 0~255

⑤ SPEED DUPLEX

- Set the transmission speed and method.

Setting	Speed and method
AUTO	Automatic negotiation
100M FULL	100Mbps full-duplex
100M HALF	100Mbps half duplex
10M FULL	10Mbps full duplex
10M HALF	10Mbps half duplex

- Default setting is AUTO.

Notice:When the settings of ②~⑤ are changed, the monitor should be rebooted. (After reboot, the changed setting will be effective.)

Please contact us if you'd like the manual regarding the control by Ethernet.

4-16. Description of MENU-RESET Functions

INPUT	<RESET>		
VIDEO	LOAD FACTORY	ALL	← ①
AUDIO	▶ RESET FILE	D65	← ②
TC/WFM/VSC	RETURN		
MARKER			
CAPTURE			
UTILITY			
FUNC.SW			
P.REMOTE			
UMD/IMD			
USB MEMORY			
C.CAPTION			
NETWORK			
RESET			
INFO			
EXIT			

① Executing the initialization of setup data

- Perform this setting to restore the default settings.
- ALL : Factory settings are restored for all PRESET data, all MENUs and switches.
- PRESET : Factory settings are restored for all PRESET data.
- MENU&SW : Factory settings are restored for all MENUs and switches.
- To initialize, select an item to be initialized with the **RE** and press the **RE**. The confirmation message appears. Press the **RE** again. To cancel the initialization, just press the **ESC** switch.

* The initialization of data cannot be executed if "PRESET LOCK" or "ALL LOCK" is set in "MENU-SYSTEM LOCK-UTILITY".

To initialize the data, unlock the settings.

② Selecting the preset files to be initialized

- When "PRESET" is selected in ①, select a file for restoring the setup data to the factory-settings.
- ALL : All the preset files are initialized.
- FILEx : FILEx only is initialized.
(x:1 to 8)
- FILE1-8 : FILE1 to FILE8 only are initialized.
- D65 : REF D65 only is initialized.
- D93 : REF D93 only is initialized.
- D65/D93 : REF D65 and D93 only are initialized.

4-17. Description of MENU-INFO Functions

INPUT	<INFO.>		
VIDEO	FORMAT	*****	①
AUDIO	PRODUCT NAME	*****	②
TC/WFM/VSC	▶ PRESET FILE	D65	③
MARKER	▶ BACKLIGHT DIM	**	④
CAPTURE	▶ FUNCTION1 MODE	WFM ON	⑤
UTILITY	▶ FUNCTION2 MODE	TC ON	⑥
FUNC.SW	▶ FUNCTION3 MODE	MIX TEST	⑦
P.REMOTE	▶ FUNCTION4 MODE	VSC ON	⑧
UMD/IMD	MPU VERSION	**.*	⑨
USB MEMORY	FPGA VERSION	**.*	⑩
C.CAPTION	WORKING TIME	** H	⑪
NETWORK	FAN TIME	** H	⑫
RESET	RETURN		
INFO			
EXIT			

- ① **Displaying the format**
 - Displays the format of the signal being displayed.
- ② **Displaying the model name**
 - Displays model name.
- ③ **Displaying the file name**
 - Displays the name of the file being set.
- ④ **Displaying the backlight value**
 - Displays the set backlight value.
- ⑤ **Displaying of F1 switch assignment function**
 - Displays the function assigned to the F1 switch.
- ⑥ **Displaying of F2 switch assignment function**
 - Displays the function assigned to the F2 switch.
- ⑦ **Displaying of F3 switch assignment function**
 - Displays the function assigned to the F3 switch.
- ⑧ **Displaying of F4 switch assignment function**
 - Displays the function assigned to the F4 switch.
- ⑨ **Displaying the MPU version**
 - Displays the current software version.
- ⑩ **Displaying the FPGA version**
 - Displays the current FPGA version.
- ⑪ **Displaying the working time**
 - Displays the accumulated time since the power was turned on.
- ⑫ **Displaying the working time of the FAN**
 - Displays the accumulation time when the FAN is activated.

5. Preset Menu Function

5-1. List of preset menu

- To execute the preset menu, press **PRESET**.
- * Turn off the menu screen.

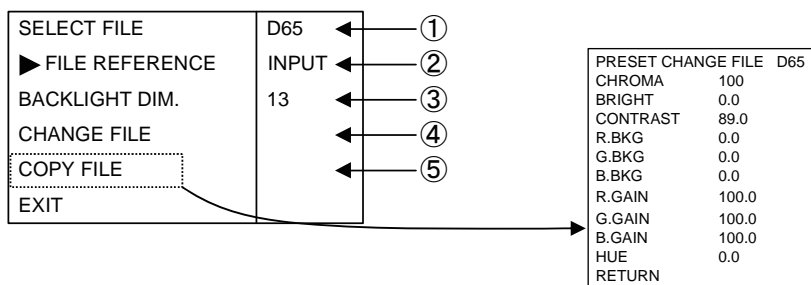

① Selection of files

- Select a file from among D65, D93 and FILE1 to FILE8.
 - D65 : 6500K
 - D93 : 9300K
 - FILE1-8 : User files
- The following data is memorized in these 10 files.
 - HUE : Hue data (only for NTSC signals)
 - CHROMA : CHROMA data
 - BRIGHT : BRIGHTNESS data
 - CONT : CONTRAST data
 - R.GAIN : R.GAIN data
 - G.GAIN : G.GAIN data
 - B.GAIN : B.GAIN data
 - R.BKG : R.BACKGROUND data
 - G.BKG : G.BACKGROUND data
 - B.BKG : B.BACKGROUND data
- * The D65 and D93 have been factory-set for the color temperatures of 6500K and 9300K, respectively. The FILE1 thru -8 data have been factory-set to be the same as for the D65.

② Setting a file change at the time of channel change

- Set the association of channel change with file change.
 - INPUT: Files are memorized for each channel: When a channel is changed to another, the stored file is recalled automatically.
 - COMMON: Just one preset file is fixed for all channels.
- Default setting is INPUT.

③ Setting the backlight brightness level

- When the backlight brightness level is raised, the black level is also slightly raised. Therefore set the backlight brightness level according to the ambient condition.
- This function can be assigned to a function switch on the front panel.
- Default setting are as follows.

HTM-960WR	: 17
HLM-1760WR	: 13
HLM-2460WR	: 16

※ Use at lower backlight brightness level extends the life span of the backlight.

④ Change of preset data

PRESET CHANGE FILE D65	
CHROMA	100
BRIGHT	0.0
CONTRAST	89.0
R.BKG	0.0
G.BKG	0.0
B.BKG	0.0
R.GAIN	100.0
G.GAIN	100.0
B.GAIN	100.0
HUE	0.0
RETURN	

- Change the data of a file selected in "① Selection of files".
- How to change data
 - Select "CHANGE FILE" and press the **RE**.
 - The following "PRESET CHANGE FILE" menu appears.
- Adjustable
 - CHROMA
 - Used to set the color density.
 - Variable range : 0~200
 - Default setting is 100.
 - BRIGHT (BRIGHTNESS)
 - Used to set the black level.

Variable range : -60.0~+60.0

- Default setting is 0.0.

• CONT (CONTRAST)

Used to set the white level.

Variable range : 0.0~120.0 (WIDE : 0.0~200.0)

• R.BKG (R.BACKGROUND)

Used to set the black balance (red component) at dark level.

Variable range : -25.0~+25.0

- Default setting is 0.0.

• G.BKG (G.BACKGROUND)

Used to set the black balance (green component) at dark level..

Variable range : -25.0~+25.0

- Default setting is 0.0.

• B.BKG (B.BACKGROUND)

Used to set the black balance (blue component) at dark level..

Variable range : -25.0~+25.0

- Default setting is 0.0.

• R.GAIN

Used to set the white balance (red component) at bright level.

Variable range : 0.0~200.0

- Default setting is 100.0.

• G.GAIN

Used to set the white balance (green component) at bright level.

Range : 0.0~200.0

- Default setting is 100.0.

• B.GAIN

Used to set the white balance (blue component) at bright level.

Range : 0.0~200.0

- Default setting is 100.0.

• HUE

Used to set the hue (only for NTSC signals).

Variable range : -17.5~+17.5

- Default setting is 0.0.

⑤ Copying of file data

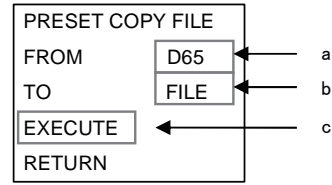

- Select the source file (D65, D93, FILEx [x: 1 to 8]) using the **RE**.
- Select the destination for the file (FILEx [x: 1 to 8], FILE1 - FILE8) using the **RE**.
 - * When FILE1 - FILE8 are selected, data is copied to FILE1 through FILE8.
- When the **RE** is pressed, the copy confirmation message appears. To copy, press the **RE** again. If not, press the **ESC** switch.

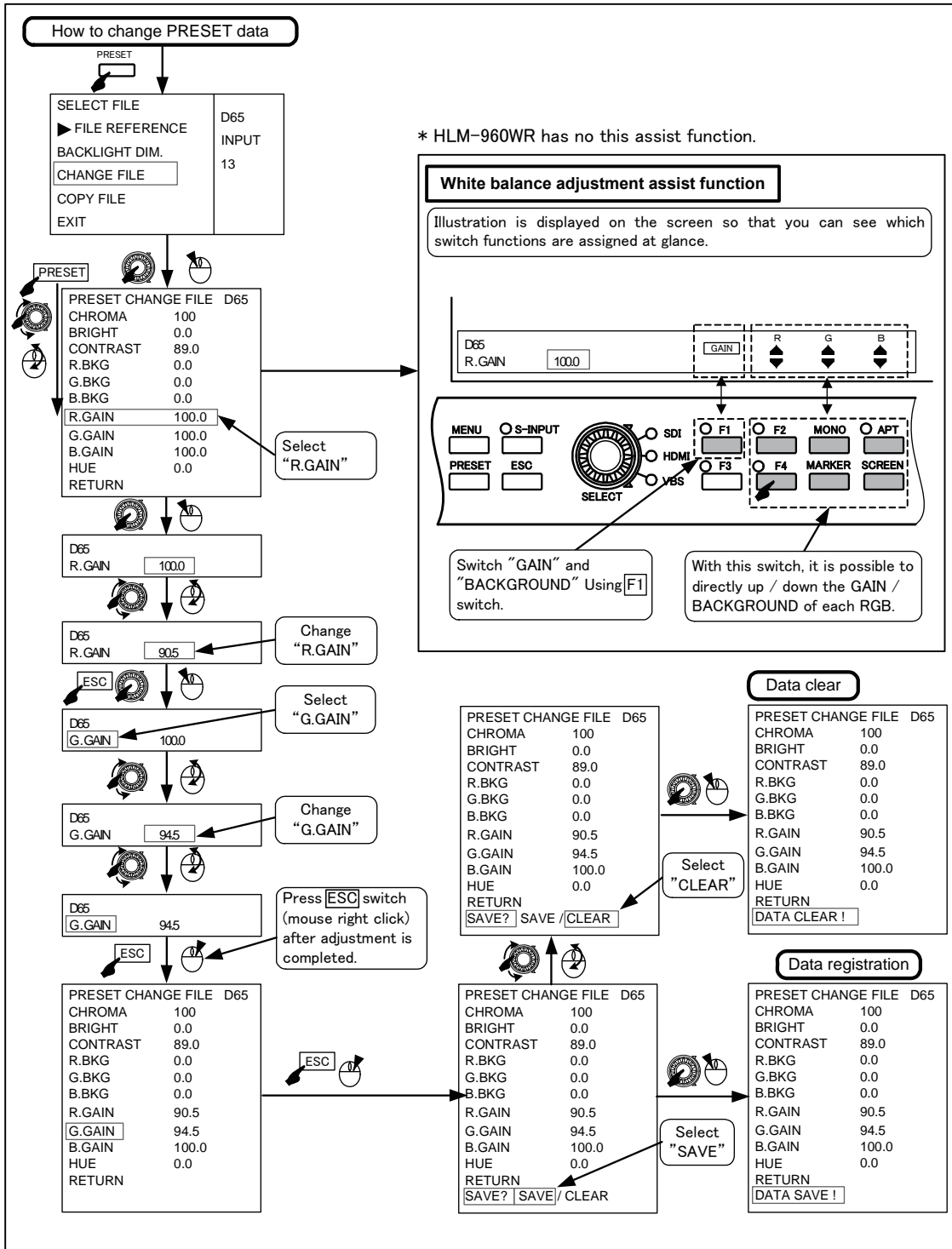

6. Mouse menu function

6-1. Basic procedure of the mouse menu

Basic behavior of the mouse
 The USB mouse requires the following 4 functions. Remote control is enabled using a 2.4GHz wireless mouse.

The mouse basically behaves in the same way as the switches on the front panel bottom.

① Double click
• The mouse menu is display.

② Left click
• A selected item on the menu is moved to the right.
• The data is registered.

③ Right click
• A selected item in the menu is moved to the left.
• The data is cleared.

④ Scroll wheel
• The mouse menu is enlarged.
• The data is modified.

<Normal screen>

① The MAIN menu is displayed
All operations of MENU are possible.

1. INPUT	<INPUT>	SDI CH-A EXECUTE
VIDEO	VIDEO SOURCE	OFF
AUDIO	SOURCE SELECT	RGB
TC/WFM/VSC	SDI CH LOCK	AUTO
MARKER	HDMI(DVI)FORMAT	Side by Side
CAPTURE	RGB RANGE	SDI CH-B SYNCHRONOUS
UTILITY	▶ PIP	OUT AB
FUNC.SW	▶ MODE	▶ CH-A
P.REMOTE	▶ SUB DISPLAY	▶ CH-B
LMD/IMD	▶ TIMING MODE	▶ CH-C
USB MEMORY	SDI CH-C/D MODE	CH-D
C.CAPTION		GRAY SCALE
NETWORK		EXECUTE
RESET	TEST PATTERN	
INFO	MIX TEST SIGNAL	
EXIT	RETURN	

② The PRESET menu is displayed.
All operations of PRESET MENU are possible.

SELECT FILE	D65
▶ FILE REFERENCE	INPUT
BACKLIGHT DIM.	13
CHANGE FILE	
COPY FILE	
EXIT	

③ The VIDEO SOURCE menu is displayed.
All inputs can be switched, including the TEST signal.

<VIDEO SOURCE>	
▶ SDI CH-A	
SDI CH-B	
SDI CH-C	
SDI CH-D	
HDMI	
VBS	
TEST	
EXIT	

④ The FUNCTION menu is displayed.
All the switches on the front operation section can be controlled.

<FUNCTION>	
1 : (blnak)	
2 : (blank)	
3 : (balnk)	
4 : (blank)	
MONO	
MARKER	
APERTURE	
SCREEN	

- 60 -

6-2. Basic procedures on the MENU and PRESET MENU screens

① Basic mouse behavior on the MENU screen

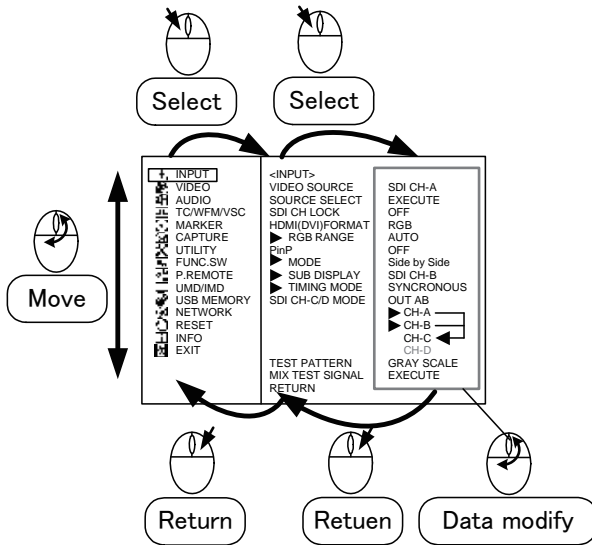

- Left-click the mouse to go to the right of the MENU screen and select an item. Right-click it to return to the left-hand items.
- The scroll wheel is used to move vertically and to change the settings.
- When there are two or more settings to select on the right-hand data like the USB memory's date setting, left-click the mouse to go to the settings to modify.

③ Basic mouse behavior on the CHANGE PRE-SET screen

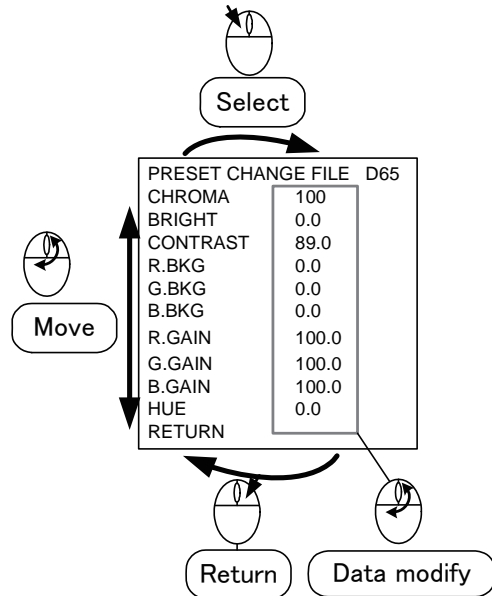

- The behavior is the same as Item ①.

② Basic mouse behavior on the PRESET MENU screen

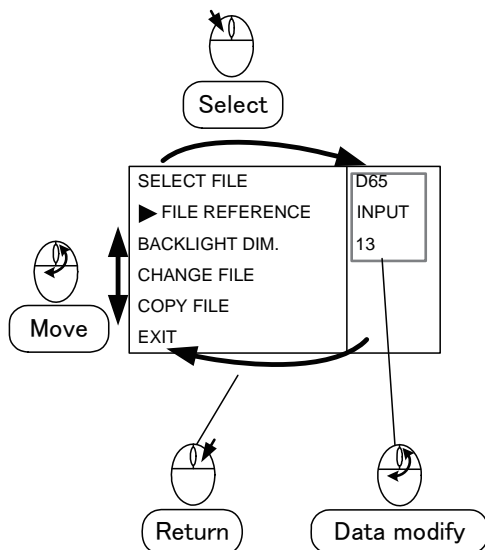

- The behavior is the same as Item ①.

④ Basic mouse behavior on the USER MARKER screen

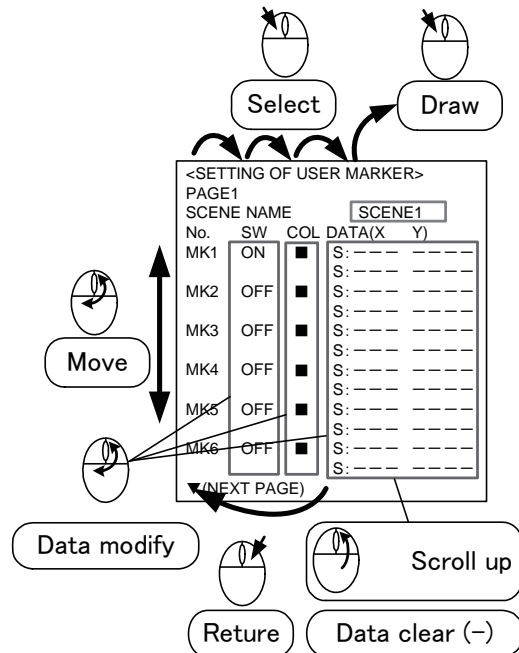

- The behavior is the same as Item ①.

7. Specifications

7-1. General specifications

Supply voltage

- a) AC input
- 100 V – 120 V ± 10 % 50 / 60 Hz
 - 200 V – 240 V ± 10 % 50 / 60 Hz
- b) DC input
- +12 V (+10.5 V – +18 V)
 - * HLM-2460W has no DC input.

Power consumption

- a) AC input
- HLM-960WR : 28 Wmax
AC 100 – 120 V : 0.33 Amax
AC 200 – 240 V : 0.18 Amax
 - HLM-1760WR : 40 Wmax
AC 100 – 120 V : 0.46 Amax
AC 200 – 240 V : 0.24 Amax
 - HLM-2460W : 66 Wmax
AC 100 – 120 V : 0.74 Amax
AC 200 – 240 V : 0.38 Amax
- b) DC input (DC +12 V)
- HLM-960WR : 27 Wmax / 2.4 Amax
 - HLM-1760WR : 36 Wmax / 3.2 Amax
 - *HLM-2460W has no DC input.

Ambient operating temperature/humidity, ambient storage temperature/humidity

- Operation: 0 °C to +40 °C / 20 % to 85 %
(no condensing)
- Storage: -20 °C to +60 °C / 5 % to 85 %
(no condensing)

Outside dimensions (excluding protrusions)

- HLM-960WR:
222.4(W)*173(H)*69.5(D)mm, 4U
- HLM-1760WR: 428(W)*301(H)*80(D)mm, 7U
- HLM-2460W :562(W)*398(H)*86(D)mm, 9U

Weight (excluding the stand and option)

- HLM-960WR : Approx.1.7 kg
- HLM-1760WR : Approx.5.8 kg
- HLM-2460W : Approx.9.1 kg (monitor)
Approx.2.3 kg (stand)

7-2. Rated performance

SDI signal (supported as standard)

- a) Input/output terminal
- Input: BNC 2 lines
- Output: BNC 2 lines
- (Two outputs can be changed to inputs by Menu setting)
- b) Input signal format (Auto detection)
- 3G-SDI (4:2:2, LEVEL-A/B)
1080p/60,59.94 1080p/50

- HD-SDI
1035i/60,59.94 1080p/25
1080i/60,59.94 1080p/24,23.98
1080i/50 720p/60,59.94
1080psF/30,29.97 720p/50
1080psF/25 720p/30,29.97
1080psF/24,23.98 720p/25
1080p/30,29.97 720p/24,23.98
- SD-SDI (4:2:2)
480i/59.94 576i/50

- c) Embedded audio
- Sampling frequency : 48 kHz
(Synchronized with video clock)
- d) Embedded audio output
- By selecting one pair of channels from ch1/2, ch3/4, ch5/6, and ch7/8 and DOWNMIX, the audio can be output from the headphone output terminal, and built-in speaker.

Analog composite (NTSC/PAL) signal

- a) Input terminal
- BNC 1 line (Loop through, High impedance)
- b) Input signal format
- NTSC composite signal
- PAL composite signal
- c) Input level
- VS : 1.0Vp-p, Positive polarity
- V : 0.714Vp-p (NTSC)/0.7Vp-p (PAL),
Positive polarity
- d) Input impedance
- High impedance bridge connection or 75Ω termination
(75Ω termination plug is optional.)

HDMI signal

- a) Input terminal
- HDMI 1 line
- b) Input signal format
- | | |
|------------------|---------------|
| 1080i/60,59.94 | 720p/60,59.94 |
| 1080i/50 | 720p/50 |
| 1080psF/30,29.97 | 720p/30,29.97 |
| 1080psF/25 | 720p/25 |
| 1080psF/24,23.98 | 720p/24,23.98 |
| 1080p/60,59.94 | 480i/59.94 |
| 1080p/50 | 576i/50 |
| 1080p/30,29.97 | 480p/59.94 |
| 1080p/25 | 576p/50 |
| 1080p/24,23.98 | |
- HDMI(PC) signal format
→Refer to "Data 1 PC Input Signal Compatible Format".
- c) HDCP
- HDCP support

- d) Audio format
L-PCM
- e) Audio output
By selecting one pair of channels from ch1/2, ch3/4, ch5/6, and ch7/8 and DOWNMIX, the audio can be output from the headphone output terminal, and built-in speaker.

Embedded audio level meter

- a) Display method
Superimposed on screen
- b) Display channel
8 ch
- c) Display position
4 types
- d) Display mode
8 modes
- e) Display segment
26 segments (including -∞)
- f) Segment point
-∞, -60, -54, -48, -44, -40, -38, -36, -34, -32, -30, -28, -26, -24, -22, -20, -18, -16, -14, -12, -10, -8, -6, -4, -2, 0 dBFS
- g) Display color
Reference level (-18 dBFS or -20 dBFS) is select in MENU.
 - -20 dBFS
-∞ — -22 dBFS:Green
-20 — -2 dBFS:Yellow
0 dBFS:Red
 - -18 dBFS
-∞ — -20 dBFS:Green
-18 — -2 dBFS:Yellow
0 dBFS:Red
- h) Peak hold
About 1 sec
* It can be set to "OFF" in the MENU.
- i) Release time
About 0.4 sec

Analog audio input

- a) Input terminal
Φ3.5 Stereo mini jack type
- b) Input level
0 dBVmax
*0 dBV = 1 Vrms

Headphones output

- a) Output terminal
Φ 3.5 Stereo mini jack type
- b) Output
85 mW/ch (RL: 32 Ω)
- c) Input signal source
Analog audio signal or embedded audio signal can be output.

To select one of these signals, make the setting in MENU (DOWNMIX, CH1/2, CH3/4, CH5/6, CH7/8).

Speaker output

- a) Rated output (monaural)
1W or more
- b) Input signal source
Analog audio input or embedded audio input can be output. A signal to be outputted is set in MENU (DOWNMIX, CH1/2, CH3/4, CH5/6, CH7/8).
* With the headphones connected, no sound is heard from the speaker.

Color temperature setting

10 types: D65, D93, and USER setting: 8 types (FILE 1 to 8)

7-3. Specifications for LCD Panel

Number of pixels

1920 (H) x 1080 (V) dots
1920 (H) x 1200 (V) dots (HLM-2460W only)

Screen size (display area)

HLM-960WR : 198.72 mm(H) x 111.78 mm(V)
(Diagonal:22.8 cm,9.0 V type)
HLM-1760WR : 365.8 mm(H) x 205.7 mm(V)
(Diagonal:42 cm,16.5 V type)
HLM-2460W : 518.4 mm(H) x 324 mm(V)
(Diagonal:61.1cm, 24.1 V type)

Peak Brightness (brightness performance for a single panel)

HLM-960WR : 400 cd/m² (typ.)
HLM-1760WR : 450 cd/m² (typ.)
HLM-2460W : 400 cd/m² (typ.)

Number of display colors

HLM-960WR : 16,777,216 colors
HLM-1760WR/2460W : 1,073,741,824 colors

Viewing angle

Vertical/horizontal : 178 °

* Black spots and luminescent spots may occur in 0.01% or less of the effective pixels of this product. This is not a failure.

7-4. Functions

Front operation

- Switch
POWER ON/OFF, MONO, APT(*), MARKER, SCREEN(*), F1, F2, F3, F4, MENU, PRESET, ESC, S-INPUT

* : This switch does not exist in HLM – 960WR.
It can be assigned to a FUNCTION

switch.

- Variable Control
CHROMA, BRIGHTNESS, CONTRAST,
AUDIO
- Rotary encoder
Various settings

Marker function

Center marker

(Set to ON/OFF using the MENU)

Safety marker

Any of the following markers is displayed according to the image aspect ratio (4:3/16:9).

The numbers in parentheses shows the aspect at the time of marker display.

<Types>

- “Safety area marker” + 100 % (4:3/16:9)
The “safety area markers” are effective over the entire screen and can be preset in 1 % increments in the range of 80-99 %.
- 5 divided crosshatch (4:3/16:9)
- 10 divided crosshatch (4:3/16:9)
- Cross (4:3/16:9)
- 16:9 aspect marker (4:3)
- 15:9 aspect marker (4:3/16:9)
- 14:9 aspect marker (4:3/16:9)
- 13:9 aspect marker (4:3/16:9)
- 4:3 aspect marker (16:9)
- 1.85:1 aspect marker (16:9)
- 2.35:1 aspect marker (16:9)
- “Each aspect marker” + “Safety marker in aspect” (4:3/16:9)

The “safety marker in aspect” refers to the safety marker with respect to the aspect marker display zone, and can be preset in 1 % increments in the range of 80-99 %.

Corresponding to each aspect marker.

<Marker level>

- Set in five steps of 20 %, 40 %, 60 %, 80 % and 100 %

Shadow function

Creates a shadow outside the aspect areas with 4:3 (16:9 mode), 13:9, 14:9, 15:9, 16:9 (4.3 mode), 1.85:1 (16:9 mode) and 2.35:1 (16:9 mode).

<Types>

- “Various aspect markers” + “Shadow”
- “Various aspect markers” + “Safety marker in aspect” + “Shadow”
- Shadow only

<Shadow contrast level>

- Set in four steps of 0 %, 20 %, 40 % and

60 %.

User marker function

Function for the user to draw their desired lines and boxes in the unit of pixels.

- a) No. of types: 10 scenes x 12 types (1 scene: 12 types)
- b) No. of colors: 7
- c) Drawable sizes: 1920 x 1080 pixels
- d) Drawing method: **RE** or USB mouse
* Patent acquisition

UMD/IMD display with TSL protocol

Character display function controlled by RS485.

Either TSL or user display should be selected for the UMD/IMD display (MENU selection).

- a) Standard: RS485
- b) Connector: R J-45 (loop through)
- c) Number of connections: up to 32 devices (per line)
- d) Protocol: TSL UMD V3.1
- e) Characters: ASCII (alphanumeric), up to 8 characters, 7 colors
- f) TALLY display: Red/Green/Amber
Display in the screen or LED display
- g) Display position: Top/bottom

UMD/IMD display with user display

A function used to set a material name on a channel basis (SDI-A, SDI-B, SDI-C, SDI-D, HDMI, VBS) and display the material name when switching the inputs.

- a) Characters: ASCII (alphanumeric), up to 8 characters, 7 colors
- b) Display position: Top/bottom

USB memory function

- a) Contents of the memory
 - MENU setting
 - User marker
 - PRESET data
 - Full image capture (HDMI signal is exclusion)
- b) Stored image
 - No. of stored images: Max. 100 images
 - Resolution: 1920 × 1080
 - File format: Binary file for exclusive use by the monitor
 - Data capacity: Approximately 10 Mbyte

7-5. Remote Control

Parallel remote control

Input connector: HD D-SUB 15-pin

- SDI CH-A/B

- SDI CH-A/C(CH-C : Input setting)(★)
- SDI CH-A/D(CH-D : Input setting)(★)
- SDI ON/OFF
- HDMI ON/OFF (★)
- COLOR/MONO switching
- 4:3/16:9 switching
- MARKER ON/OFF
- SHADOW ON/OFF
- R TALLY ON/OFF
- G TALLY ON/OFF
- CHROMA UP ON/OFF
- SHADOW 0 ON/OFF (★)
- SHADOW 20 ON/OFF (★)
- SHADOW 40 ON/OFF (★)
- SHADOW 60 ON/OFF (★)
- USER MARKER SCENE* ON/OFF (★)
 - * : 1–10
- PinP ON/OFF
- * For the pin function, refer to **"Data 2 Parallel Remote Pin Function"**.
- * In addition to default setting, user setting is possible.
The "★" marked settings are used in the USER mode.

RS485 remote control

- (The SCR-400 controller is optional.)
- a) Connector: RJ-45 (loop-through)
 - b) Maximum number of connections: 32 units
Extension by increasing the number of lines is possible.
 - c) Protocol: TSL UMD V3.1

Wireless remote control

- (The RCT-30A controller is optional.)
- * See "Reference 4: Control with remote controller" for the control items."

Ethernet remote control

8. Mounting

Equipped with "100 mm x 100 mm" mounting holes compliant with the VESA mount interface standard.
Other mounting holes also available.
(Refer to the external view.)

9. Options

9-1. HLM-960WR/1760WR/2460W (Common)

RCT-30A

"Infrared remote controller"

Just this unit can control most of the monitor functions. Up to 99 monitors can be controlled individually.

SRC-400

"Serial remote controller"

A serial remote controller that allows you to remote control the monitor with RS485 interface by loop-through connection via LAN cable.

One controller can control all functions of monitors. By connecting the monitors with the loop-through connection via LAN cable, one line can control 32 monitors, and three lines can control up to 96 monitors individually or all at once.

Since the controller can be also connected with PC and Ethernet, it is possible to individually control each monitor from the PC screen through network control.

9-2. HLM-960WR

DR-960

"Dual rack mount adaptor"

- Designed specifically for HLM-960WR.
- 4U-size rack mount adaptor for mounting 2 units HLM-960WR.
- Weight: approx. 1.3Kg.

BP-960

"Blank panel for DR-960"

- Blank panel for mounting one monitor with DR-960.
- Weight: approx. 0.54Kg.

DR-960T (made-to-order)

"Dual rack mount adaptor (Tilt-type)"

- Designed specifically for HLM-960WR.
- 5U-size tilt rack mount adaptor for mounting 2 units.

BP-960T (made-to-order)

"Blank panel for DR-960T"

- Blank panel for mounting one monitor with DR-960T.

HR-960 (made-to-order)

"Half rack mount adaptor"

- 4U-size half rack mount adaptor for mounting one monitor.

WR-960L (made-to-order)

"WFM rack mount adaptor"

- Designed specifically for HLM-960WR.
- Monitor+WFM(Made by Leader Electronics Corp.: LV5750).
- 4U-size rack mount adaptor.

WR-960L3 (made-to-order)

"WFM rack mount adaptor"

- Designed specifically for HLM-960WR.
- Monitor+WFM(Made by Leader Electronics Corp.: LV5750A/LV5710A/5800).
- 4U-size rack mount adaptor.

WR-960L4 (made-to-order)

"WFM rack mount adaptor"

- Specific for the HLM-960WR.
- Monitor+WFM(Made by Leader Electronics Corp.: LV5380).
- 4U-size rack mount adaptor.

WR-960L5 (made-to-order)

"WFM rack mount adaptor"

- Designed specifically for HLM-960WR.
- Monitor+WFM(Made by Leader Electronics Corp.: LV5330).
- 4U-size rack mount adaptor.

WR-960A (made-to-order)

"WFM rack mount adaptor"

- Designed specifically for HLM-960WR.
- Monitor+WFM(Made by Astrodesign Inc. : WM-3007/3007A/3208).
- 4U-size rack mount adaptor.

WR-960C (made-to-order)

"WFM rack mount adaptor"

- Designed specifically for HLM-960WR.
- Monitor+WFM(Made by Tektronix, Inc.: WFM7000series).
- 4U-size rack mount adaptor.

MH-904

"Folding hood"

- Specific for the HLM-904/905/907/960WR.
- Weight: approx. 0.58Kg

CC-960

"Hard carrying case"

- Designed specifically for HLM-960WR.

SO-016

"Soft carrying case"

- Made by SEKAIDO. Inc.
- Specific for the HLM-904/905/907/960WR

STD-960

"Stand"

- Designed specifically for HLM-960WR.
- Fixed stand.

STD-960T

"Tilt-Stand"

- Designed specifically for HLM-960WR.
- Tilt angle: $\pm 10^\circ$

GR-904

"Handle"

- Specific for the HLM-904/905/907/960WR
- Weight: approx. 0.15Kg
- Easy removable.

AT-900

"Inch screw thread attachment plate"

- Attachment plate for connecting to a tripod
- For 1/4-inch and 3/8-inch threads.

BB-904V

"Battery bracket (V type)"

- Specific for the HLM-904/905/907/960WR.
- Weight: approx. 0.36Kg
- Easy removable.

BB-904A

"Battery bracket (Antonbauer type)"

- Specific for the HLM-904/905/907/960WR
- Weight: approx. 0.39Kg
- Easy removable.

PP-960

"Protection plate (antireflection panel)"

- Designed specifically for HLM-960WR.
- Easy removable.

9-3. HLM-1760WR**RS-1770**

"19-inch rack mount bracket (fixing type)"

- Height: 7U
- Weight: Approximately 0.76kg
- Color:black

RS-1770T

"19-inch rack mount bracket (angle fixing type)"

- Tilt angle: Adjustable on 4 levels with angle of 3.75° (15° Max).
- Height: 7U
- Weight: Approximately 1.6kg
- Color: black

MH-1750

- "Hood for 17-inch model"
 • Weight: Approximately 0.83kg

CC-1760 (made-to-order)

"Hard carrying case for 17-inch model"

STD-1760

- "Fixed stand"
 • Weight: Approximately 0.74kg
 • Color: Black

STD-1760T

- "Tilt-Stand"
 • Weight: Approximately 2.1kg
 • Color: Black

STD-1722M

- "Fixing stand for monitor shelf"
 • The top/bottom and left/right position can be adjusted with the VESA mount type stand.
 • Weight: Approximately 2.7kg
 • Color: Gray

GR-1770

- "Handle"
 • Weight: Approximately 0.11kg
 • Color: Blue

BB-1750V

- "Battery bracket (V mount type)"
 • Weight: Approximately 0.29 kg

BB-1750A

- "Battery bracket (anton mount type)"
 • Weight: Approximately 0.37 kg

PP-1760

- "Protection plate (antireflection panel)"
 • Weight: Approximately 0.33 kg
 • Easy removable.

9-4. HLM-2460W

RS-2450T

- "Rack mount bracket (angle fixed type)"
 Comes with 19-inch rack mount.
 • Tilt angle:7.5° / 15°

* The monitor itself is wider than the 19-inch rack mount. It should be noted, therefore, that the monitor front stretches out of the rack mount width. When setting up the rack mount, keep this in mind.

STD-240T

- "Tilt stand"
 This stand is the center pivotal type.
 Tilting angle:8° downward, 45° upward

GR-1770

- "Handle"
 • Weight: Approximately 0.11kg
 • Color: Blue

CC-2460 (made-to-order)

"Hard carrying case for HLM-2460W"

* The specifications and appearance of this product are subject to change for product improvements without notice.

10. External View

[UNIT : mm]

10-1. HLM-960WR

(1) HLM-960WR

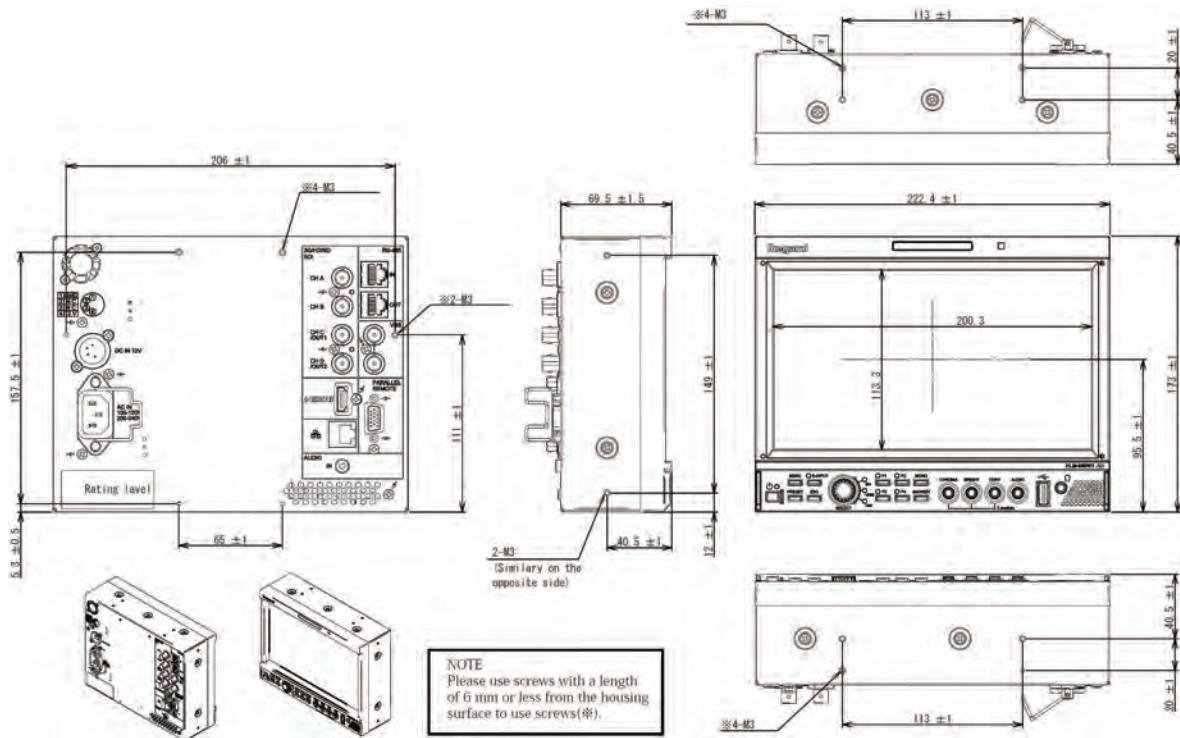

(2) HLM-960WR + STD-960 + BB-904V + PP-960

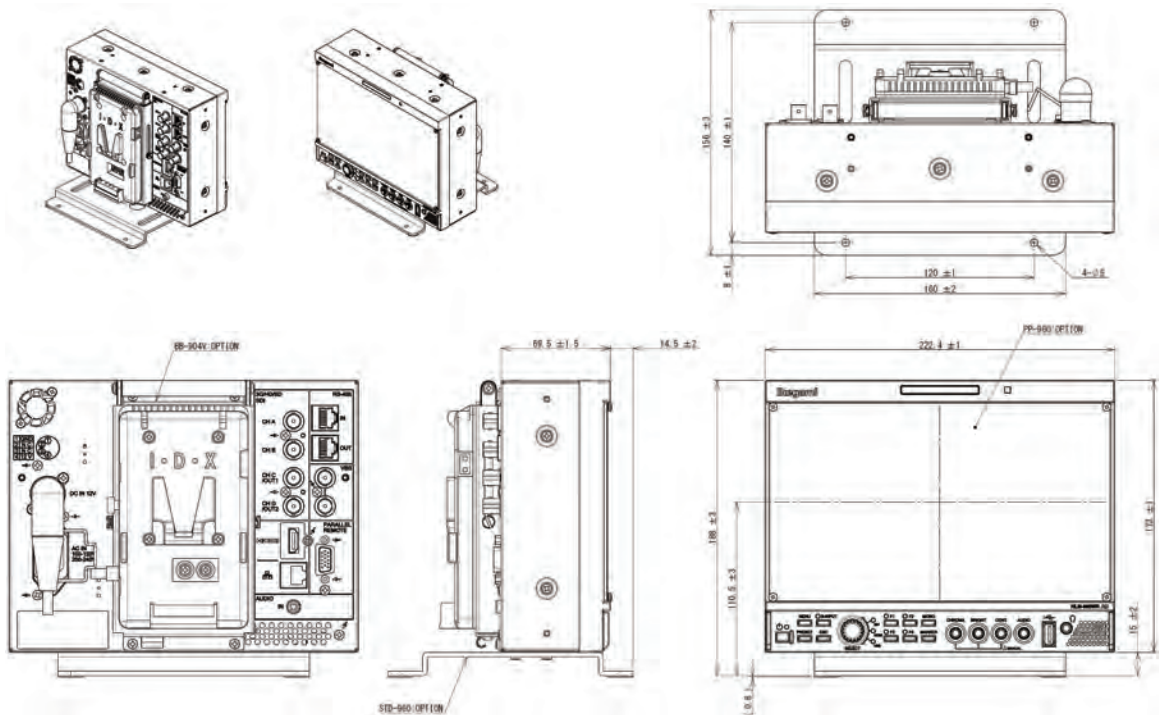

(3) HLM-960WR + STD-960T + BB-904A + PP-960

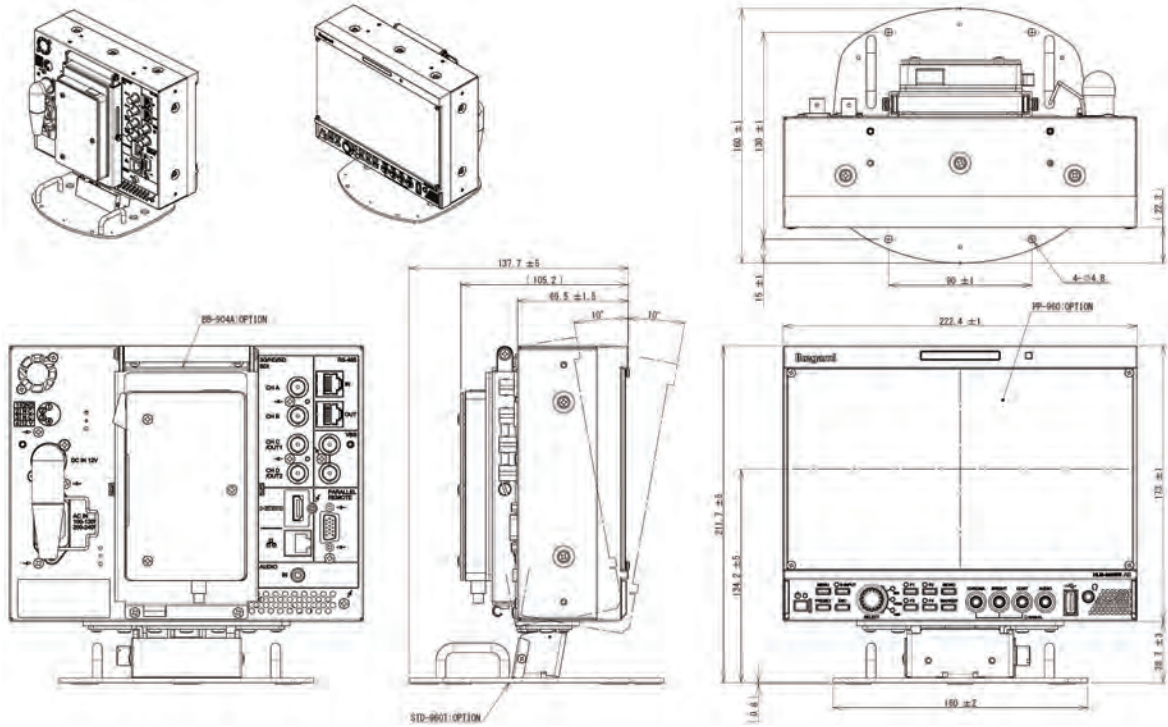

(4) HLM-960WR + DR-960

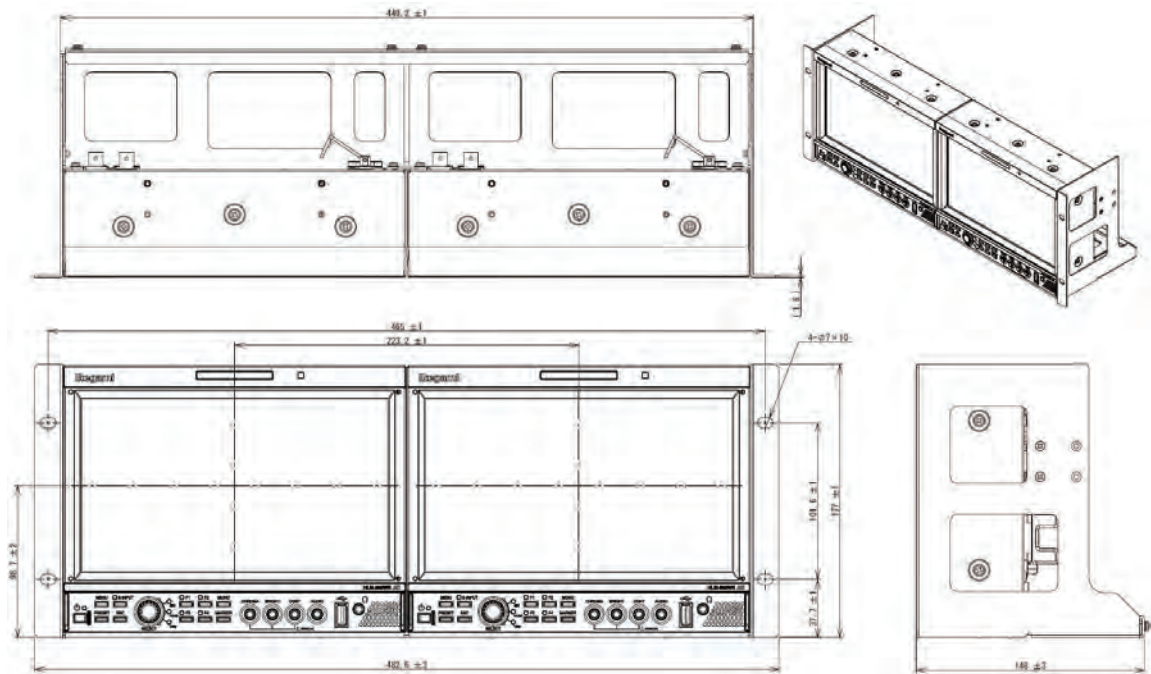

(5) HLM-960WR + HR-960

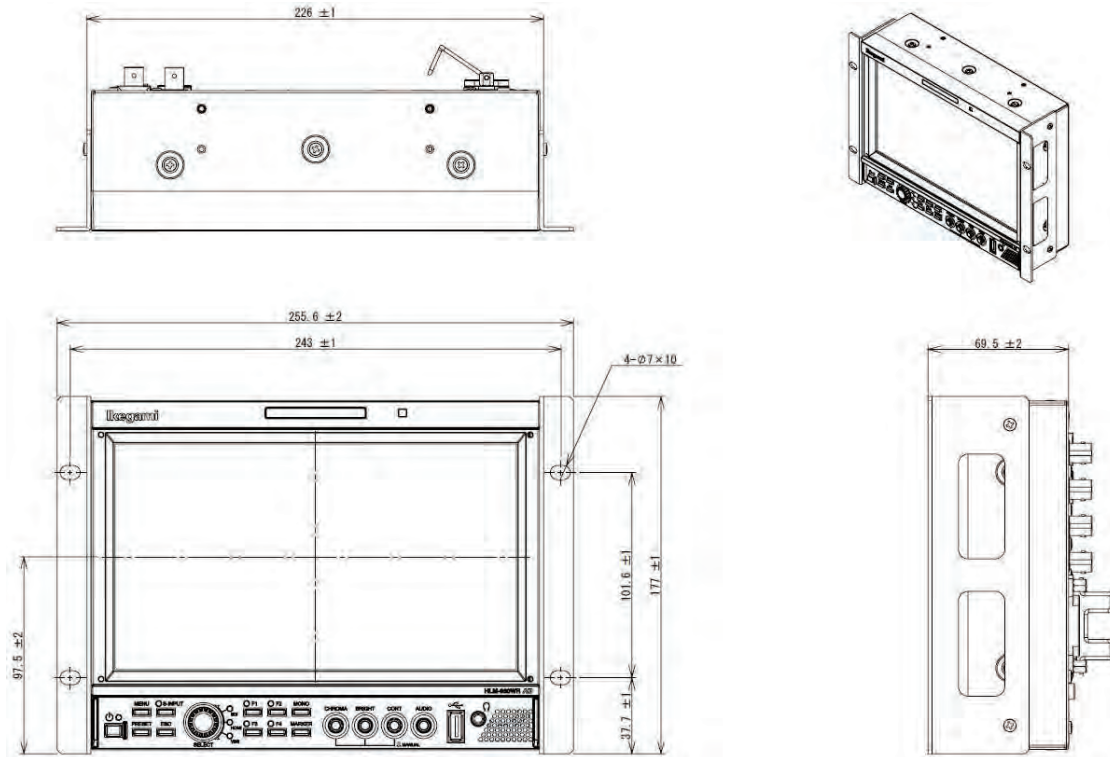

(6) AT-900

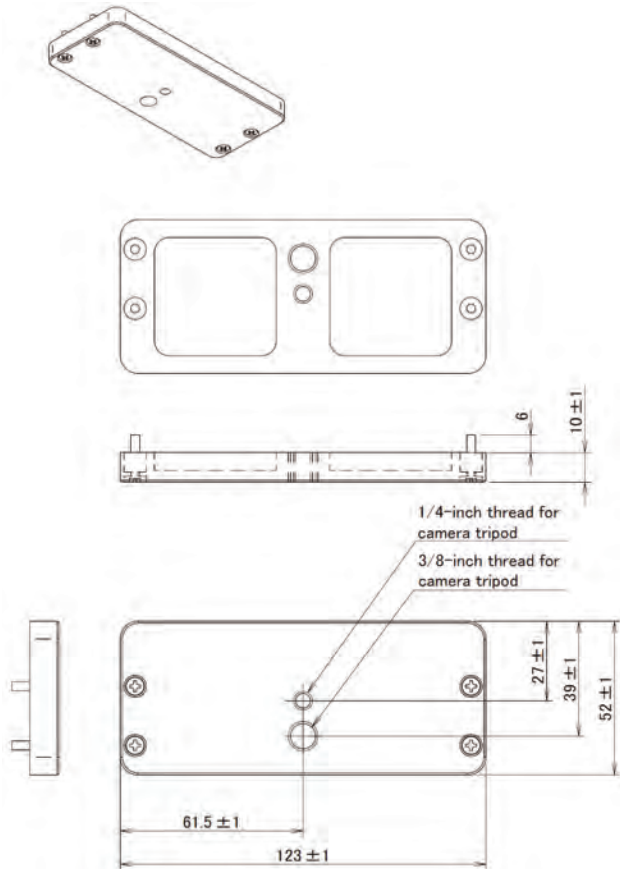

10-2. HLM-1760WR

(1) HLM-1760WR

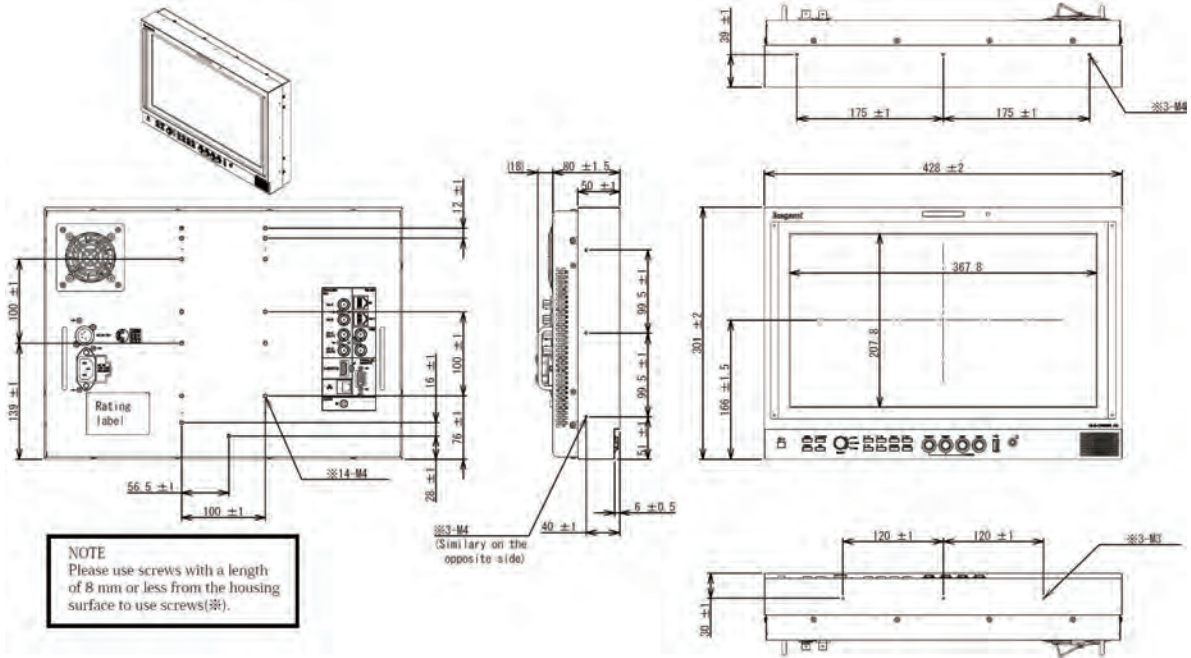

(2) HLM-1760WR + STD-1760 + BB-1750V + GR-1770 + PP-1760

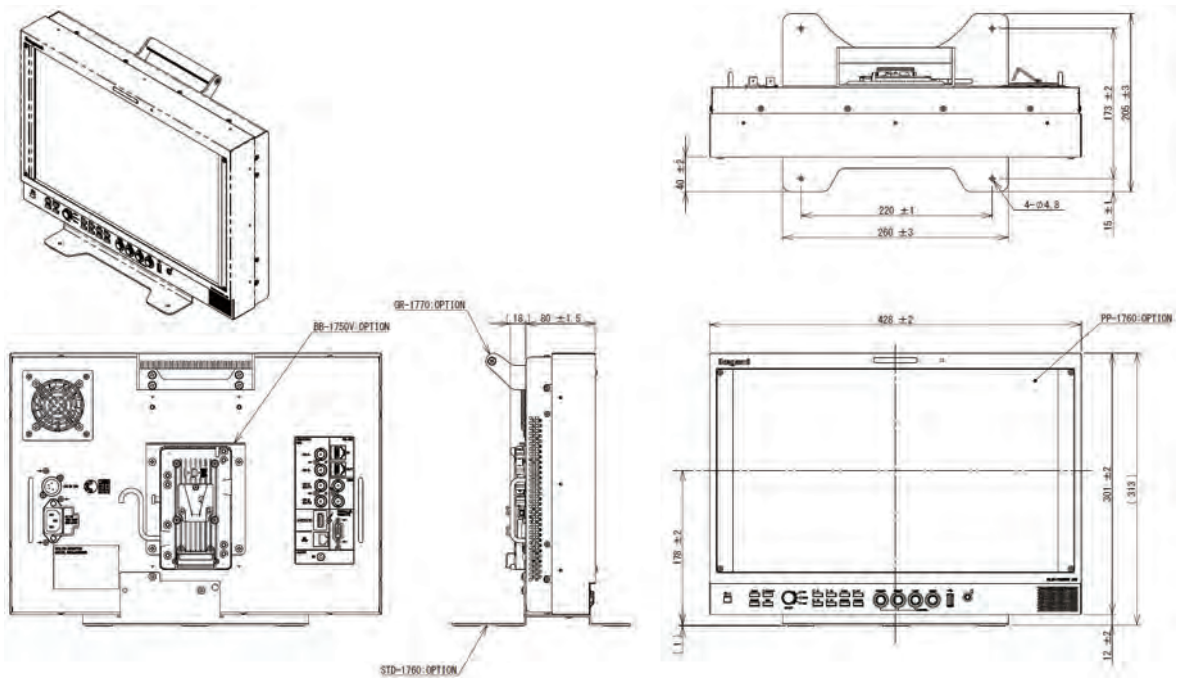

(3) HLM-1760WR + STD-1760T + BB-1750A + GR-1770 + PP-1760

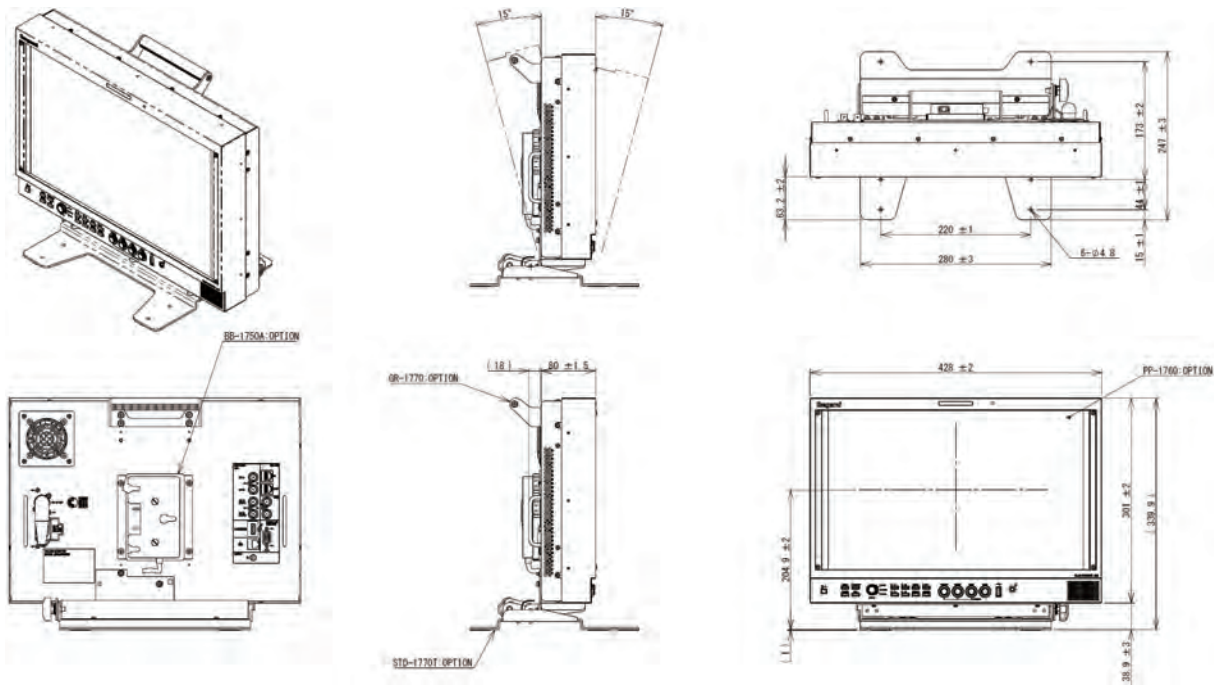

(4) HLM-1760WR + STD-1722M

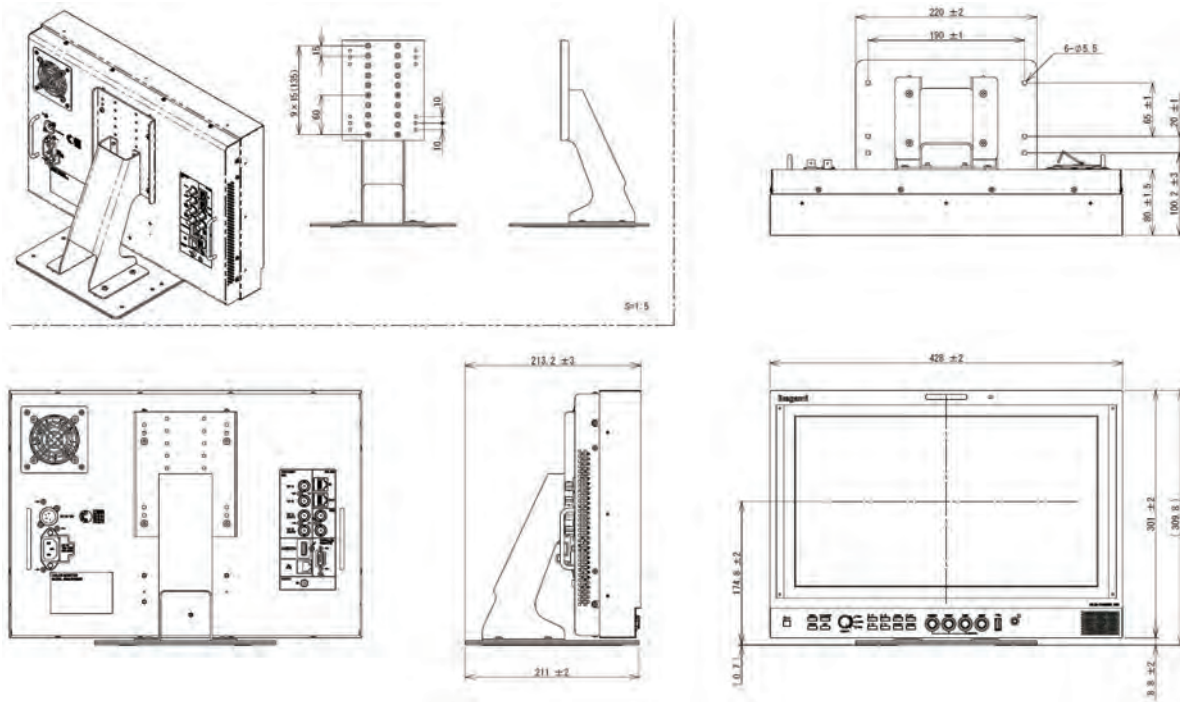

(5) HLM-1760WR + RS-1770

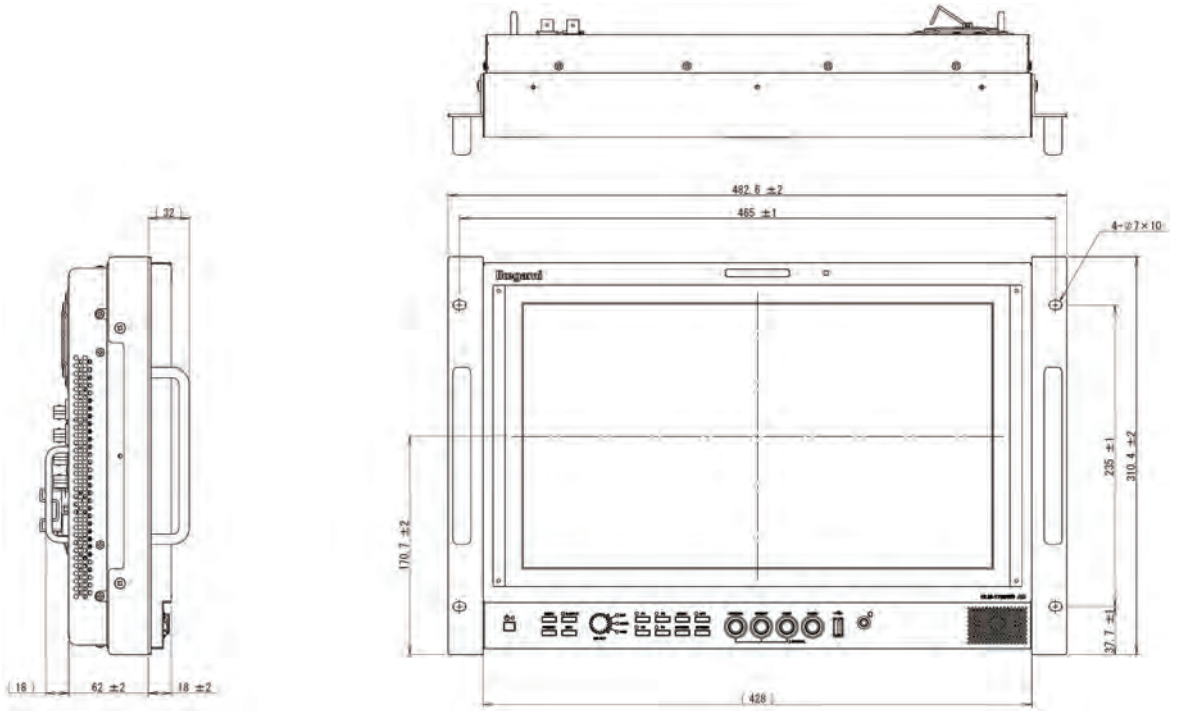

(6) HLM-1760WR + RS-1770T

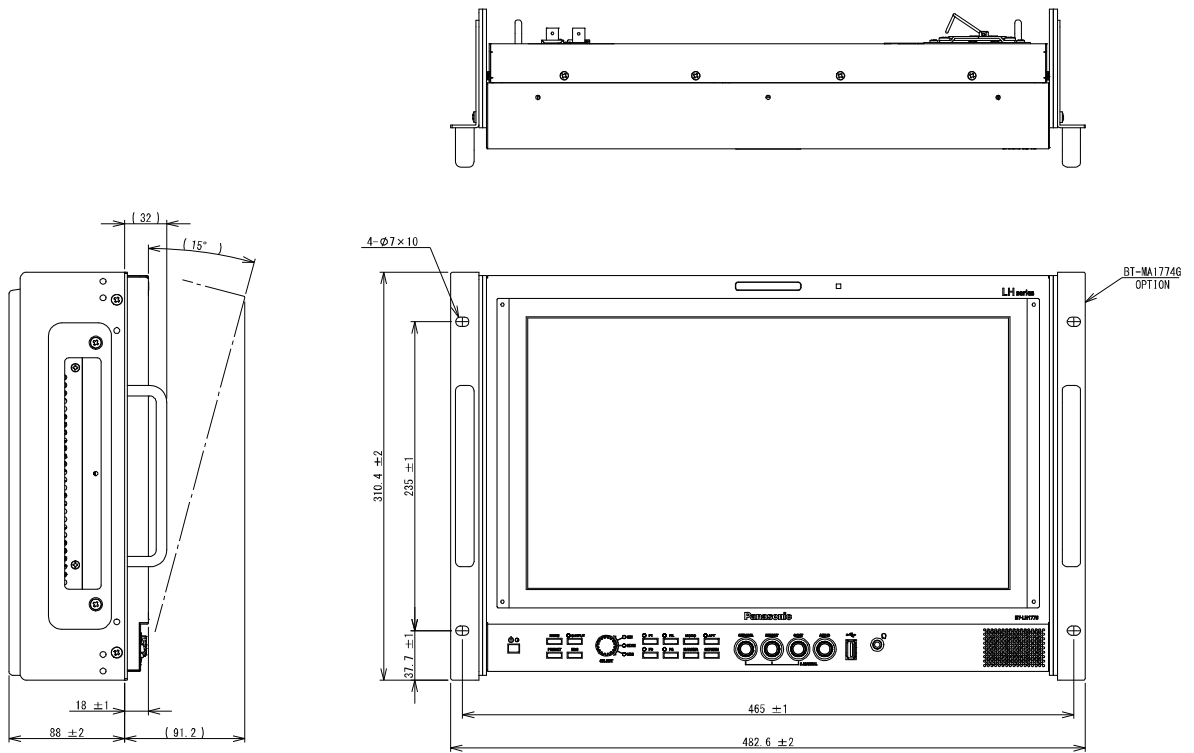

10-3. HLM-2460W

(1) HLM-2460W + standard stand

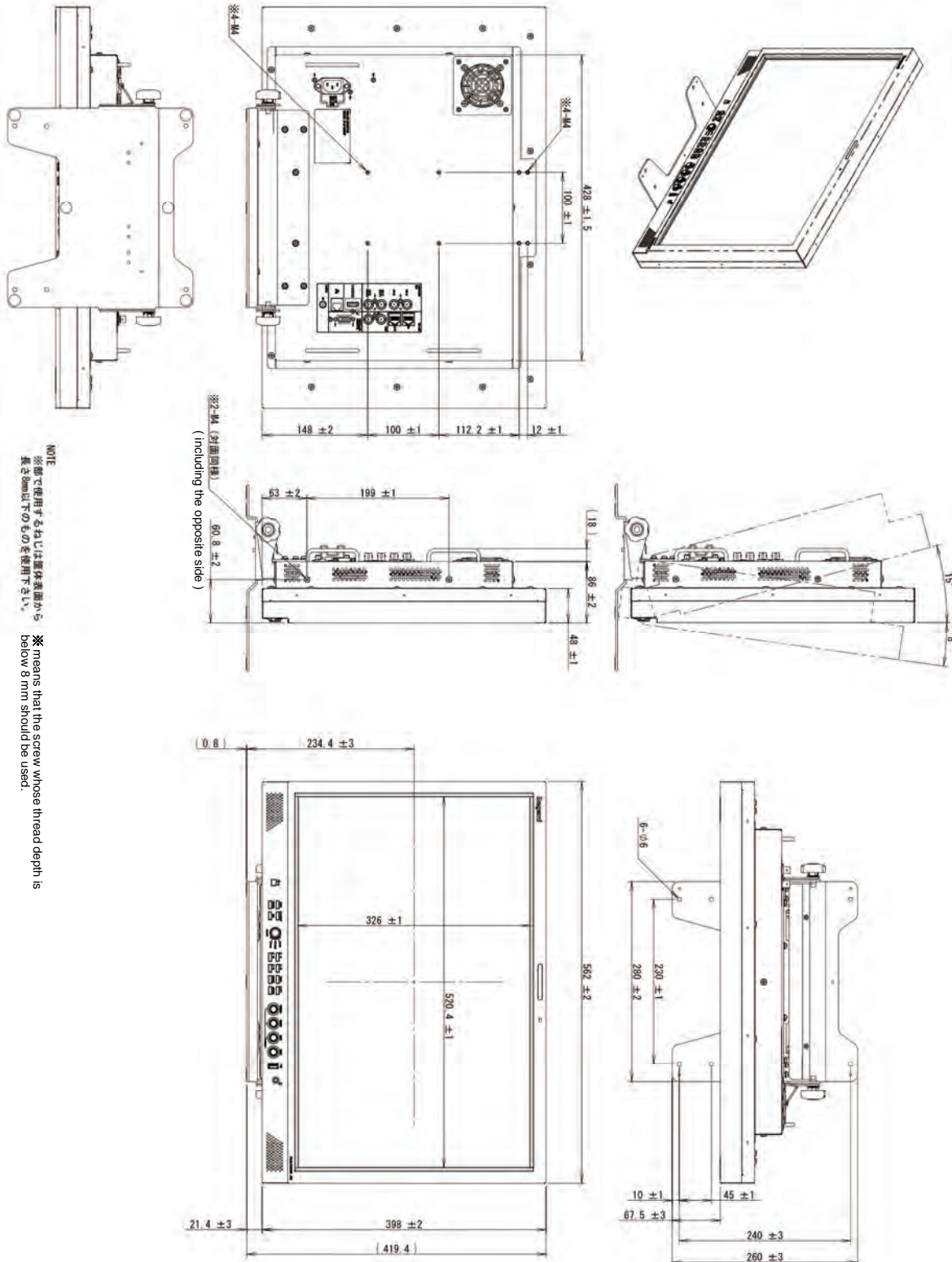

(2) HLM-2460W + STD-240T + GR-1770

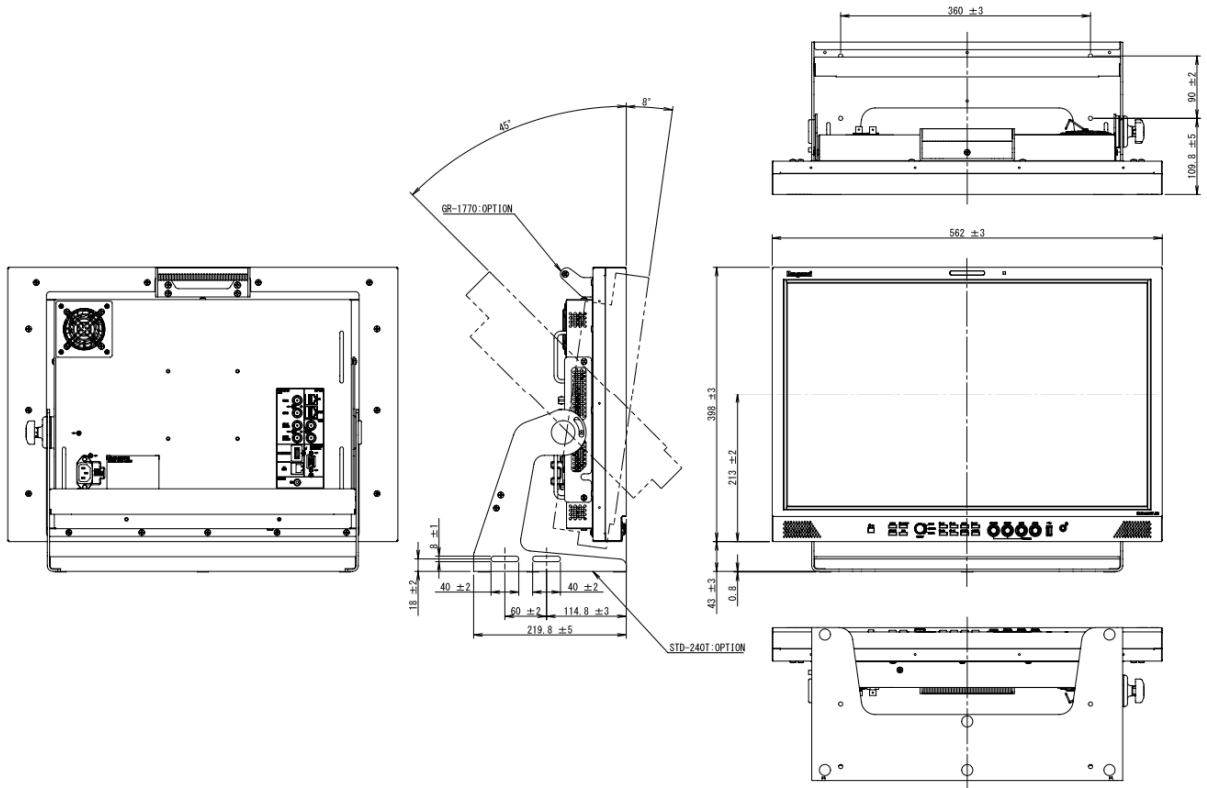

(2) HLM-2460W + RS-2450T

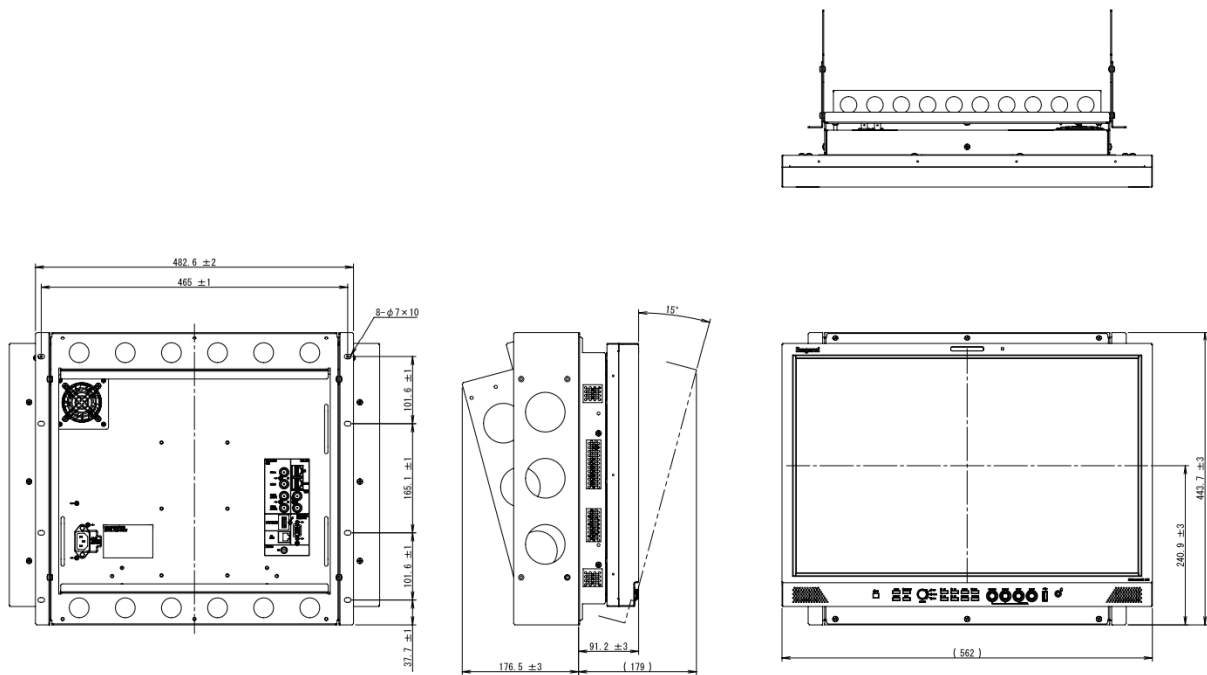

Data 1 PC Input Signal Compatible Formats

No.	Input signal	Horizontal frequency [kHz]	Vertical frequency [Hz]	Clock frequency [MHz]
1	VGA (640x480)	31.48	59.95	25.18
2		37.86	72.81	31.50
3		37.50	75.00	31.50
4		43.27	85.01	36.00
5	SVGA (800x600)	35.16	56.25	36.00
6		37.88	60.32	40.00
7		48.08	72.19	50.00
8		46.88	75.00	49.50
9		53.67	85.06	56.25
10	XGA (1024x768)	48.36	60.00	65.00
11		56.48	70.07	75.00
12		60.02	75.03	78.75
13		68.68	85.00	94.50
14	WXGA(1280x768)	48.13	60.02	81.25
15	SXGA(1280x1024)	63.98	60.02	108.00
16	UXGA(1600x1200)	75.00	60.00	162.00
17	WUXGA(1920x1200)	73.46	60.61	157.50

Data 2 Parallel Remote Pin Functions

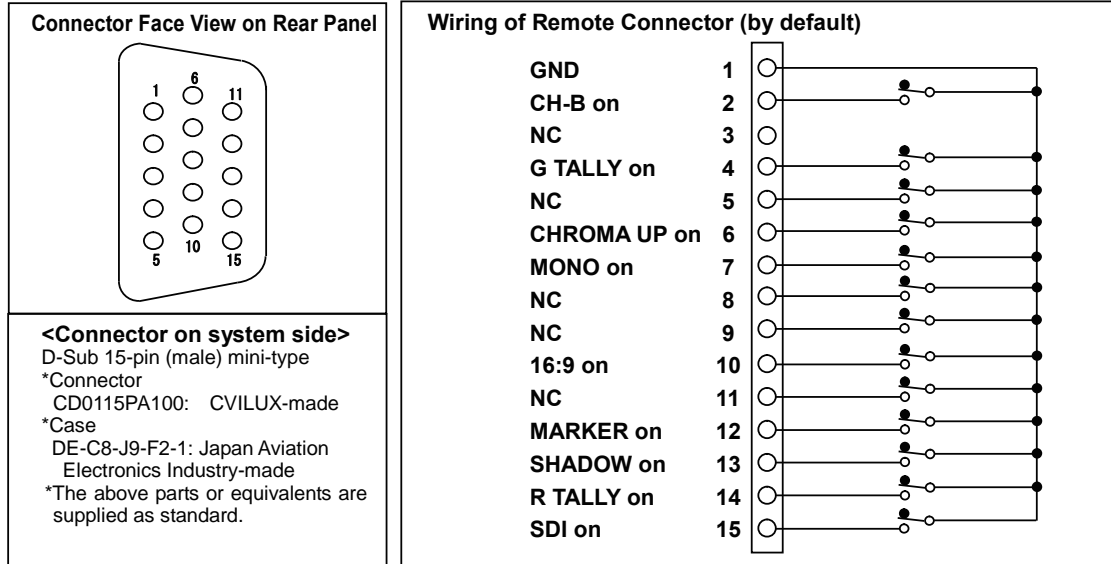

* Notes: Remote control terminals should only be controlled by "short circuit to GND pin" or "open" and not control voltage.

Application of voltage may cause failure.

■ Pin functions by default

Pin No.	Function	External Assignment for Function
1	GND	Connecting remote terminals to this pin enables ON control.
2	CH-B on	Connect to Pin 1 to select B channel in the SDI input mode. Pin 15 is also connected to Pin 1. * When Pin 2 is OPEN, the A channel will be selected.
3	NC	No connection
4	G TALLY on	Connect to Pin 1 to set G TALLY to ON.
5	NC	No connection
6	CHROMA UP on	Connect to Pin 1 to set CHROMA GAIN UP function to ON.
7	MONO on	Connect to Pin 1 to switch the COLOR/MONO setting to MONO.
8	NC	No connection
9	NC	No connection
10	16:9 on	Connect to Pin 1 to change the aspect (4:3/16:9) of SDTV signals to 16:9. * If the setting is to be controlled simultaneously with channel switching, set [ASPECT REFERENCE] to [COMMON] in MENU .
11	NC	No connection
12	MARKER on	Connect to Pin 1 to set MARKER to ON.
13	SHADOW on	Connect to Pin 1 to set SHADOW to ON. * The shadow is displayed in the MENU-MARKER -preset level.
14	R TALLY on	Connect to Pin 1 to set Red TALLY to ON.
15	SDI on	Connect to Pin 1 to select the SDI input module. Use together with Pin 2 to switch between channels A and B. * When Pin 15 is open, VBS will be selected.

■ Additional user-set functions

Pin No.	Function	External Assignment for Function
User setting	SHADOW0 on	Connect to Pin 1 for running with shadow level 0% (black). * Priority is given to this pin function if any other shadow setting pin is pressed at once.
User setting	SHADOW20 on	Connect to Pin 1 for running with shadow level 20%.
User setting	SHADOW40 on	Connect to Pin 1 for running with shadow level 40%.
User setting	SHADOW60 on	Connect to Pin 1 for running with shadow level 60%.
User setting	CH-C on	Connect to Pin 1 to select C channel in the SDI input mode. Pin 15 is also connected to Pin 1. * When CH-C is OPEN, A channel will be selected.
User setting	CH-D on	Connect to Pin 1 to select D channel in the SDI input mode. Pin 15 is also connected to Pin 1. * When CH-D is OPEN, A channel will be selected.
User setting	HDMI on	Connect to Pin 1 to select the HDMI input mode. * When HDMI and SDI are open, the analog composite will be selected.
User setting	PinP on	Connect to Pin 1 to set PinP to on.
User setting	U.MRK SCENE01	Connect to Pin 1 to set USER MARKER (SCENE01) to on.
User setting	U.MRK SCENE02	Connect to Pin 1 to set USER MARKER (SCENE02) to on.
User setting	U.MRK SCENE03	Connect to Pin 1 to set USER MARKER (SCENE03) to on.
User setting	U.MRK SCENE04	Connect to Pin 1 to set USER MARKER (SCENE04) to on.
User setting	U.MRK SCENE05	Connect to Pin 1 to set USER MARKER (SCENE05) to on.
User setting	U.MRK SCENE06	Connect to Pin 1 to set USER MARKER (SCENE06) to on.
User setting	U.MRK SCENE07	Connect to Pin 1 to set USER MARKER (SCENE07) to on.
User setting	U.MRK SCENE08	Connect to Pin 1 to set USER MARKER (SCENE08) to on.
User setting	U.MRK SCENE09	Connect to Pin 1 to set USER MARKER (SCENE09) to on.
User setting	U.MRK SCENE10	Connect to Pin 1 to set USER MARKER (SCENE10) to on.

* The functions of pins other than 1 are freely user-settable in the MENU.

* When SCENE 01 ~ 10 of USER MARKER is set with multiple pins, lower numbers are given priority.

For example, when both SCENE 01 and SCENE 03 are ON, SCENE 01 takes precedence

Data3 RS-485 Pin Functions

* For the connection between the monitor, use straight LAN cable.

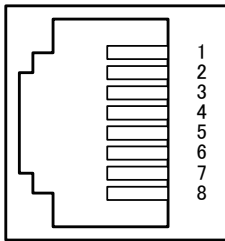

< Female terminal >

Pin No.	IN terminal	OUT terminal
1	TXD+	TXD+
2	TXD-	TXD-
3	RXD+	RXD+
4	GND	GND
5	GND	GND
6	RXD-	RXD-
7	NC	NC
8	NC	NC

Data4 Control with Remote Controller

Control item	Serial remote SRC-400	Wireless remote RCT-20A/30A	Remarks
■Switch functions			
VIDEO SELECT	—	○ (*1)	TEST mode by long press
VBS A	○	—	
VBS B	○	—	VBS is selected
SDI A	○	—	
SDI B	○	—	
DVI (HDMI)	○	—	HDMI is selectrd
COMP	×	—	
OP1 (SDI C)	○	—	SDI C is selected
OP2 (SDI D)	○	—	SDI D is selected
TEST	○	(*2)	
APERTURE ON/OFF	○	○	
COLOR/MONO	○	○	
COMB/TRAP	○ (*3)	○	
BLUE ONLY ON/OFF	○	○	
DELAY (H/V/PCR)	○	○	Valid for SDI input only
4:3/16:9 SCAN SELECT	○	○	Valid for SDTV format only
NORMAL/UNDER SCAN	○	○	
SYNC INT/EXT	—	×	
FILE SELECT	○ (*3)	○	
MARKER ON/OFF	○	—	
MARKER SELECT	○ (*3)	○	
FUNCTION1-4 ON/OFF	○	—	
MENU/ENT/ESC	○	○	
■Variable preset level functions			
HUE	○ (*4)	○ (*4)	
CHROMA	○ (*4)	○ (*4)	
BRIGHTNESS	○ (*4)	○ (*4)	
CONTRAST	○ (*4)	○ (*4)	
APERTURE LEVEL	○ (*4)	○ (*4)	
R/G/B GAIN	○ (*4)	○ (*4)	
R/G/B BACKGROUND	○ (*4)	○ (*4)	

*1 : The switch toggles the modes as follows.

「SDI-A」→「SDI-B」→「SDI-C(only the input setting)」→「SDI-D(only the input setting)」→「HDMI」→
「VBS」→ 「SDI-A」→ …

*2 : To select the TEST signal, hold down the VIDEO switch for about 3 seconds.

*3 : Operation with a FUNCTION switch.

*4 : Adjustments through MENU operation.

Notes

**MODEL HLM-960WR
HLM-1760WR
HLM-2460W
FULL HD MULTI FORMAT
LCD COLOR MONITOR**

OPERATION MANUAL

3rd edition: Jul. 2018

Published by Ikegami Tsushinki Co., Ltd.

© Jul. 2018 by Product Center

of Ikegami Tsushinki Co., Ltd.

- All right reserved. Reproduction or duplication, without permission of Ikegami Tsushinki Co., Ltd. of edition or contents in whole in part, any manner, is prohibited.
- Specifications and design are subject to change without notice.

Ikegami

Ikegami Tsushinki Co., Ltd.

5-6-16, Ikegami, Ohta-ku, Tokyo, 146-8567, Japan
Phone: +81-(0)3-5700-4114 Fax: +81-(0)3-5748-2200
URL: <https://www.ikegami.co.jp/en/>
Contact: <https://www.ikegami.co.jp/en/inquiry-general>

Ikegami Electronics (U.S.A.), Inc.

300 Route 17 South, Mahwah, New Jersey 07430, U.S.A.
Phone: +1-201-368-9171 Fax: +1-201-569-1626
URL: <https://www.ikegami.com>
Contact: <https://www.ikegami.com/contact-form>

Ikegami Electronics (Europe) GmbH

Ikegami Strasse 1, D-41460 Neuss, GERMANY
Phone: +49-(0)2131-123-0 Fax: +49-(0)2131-102820
URL: <http://www.ikegami.de>
Contact: <http://www.ikegami.de/contact.html>

Ikegami Electronics Asia Pacific Pte. LTD.

1 Tampines Central 5, #3-3 CPF Tampines Building,
Singapore 529508
Phone: (+65)6260-8820 Fax: (+65)6260-8896
URL: <https://sg.ikegami.co.jp/>
Contact: <https://sg.ikegami.co.jp/inquiry-general>

Property of