

Ikegami

Ikegami Tsushinki Co., Ltd.

User Manual

ML Serise LCD Monitor

Model MLW-2627C-DC

Thank you for choosing this Ikegami HD Monitor. Please read this Instruction manual carefully to keep your Ikegami products at peak performance for a longer service period. All Ikegami products are designed and manufactured with utmost care and craftsmanship to provide long life and high quality performance, if it is properly used and maintained as outlined in this manual.

This high performance LCD (Liquid Crystal Display Panel) monitor is equipped with the latest precision display panel of 24/26 inch diagonal size, which has an extremely accurate pixel arrangement for sharp reproduction and a lot of useful facilities and functions in a rugged but light weight and easy-to-use design to allow for a wide range of uses in many different applications for professional people.

This Ikegami product is made of ECO friendly components based upon the Company policy and corporate social responsibility to contribute towards the Global Environmental Solution for energy conservation and environmental sustainability, all the components used in this product are Non-hazardous, Toxic Free, Non-Lead and conform with Japan's Green Product regulation, EU's RoHS directive and other Environmental and hazardous chemical substances related regulations and laws.



SA 1965

CAUTION

RISK OF ELECTRIC SHOCK
DO NOT OPEN



SA 1966

CAUTION: TO REDUCE THE RISK OF ELECTRIC SHOCK, DO NOT REMOVE COVER (OR BACK). NO USER-SERVICEABLE PARTS INSIDE. REFER SERVICING TO QUALIFIED SERVICE PERSONNEL.



SA 1965

The lightning flash with arrowhead inside a triangle is intended to warn the user that parts inside the product are dangerous and many cause electrical hazards.



SA 1966

The exclamation mark inside a triangle is intended to inform users that important operating and servicing instructions are provided with the equipment.

WARNING: FOR CONTINUED SAFETY, REPLACE SAFETY CRITICAL COMPONENTS ONLY WITH MANUFACTURE'S RECOMMENDED PARTS (REFER TO SERVICE LITERATURE).

NOTE:

This equipment has been tested and found to comply with the limits for a Class A digital device, pursuant to Part 15 of the FCC Rules. These limits are designed to provide reasonable protection against harmful interference when the equipment is operated in a commercial environment. This equipment generates, uses and can radiate radio frequency energy and, if not installed and used in accordance with the instruction manual, may cause harmful interference to radio communications. Operation of this equipment in a residential area is likely to cause harmful interference in which case the user will be required to correct the interference at his own expense.

CAUTION;

ANY CHANGES OR MODIFICATIONS NOT EXPRESSLY APPROVED BY THE BODY RESPONSIBLE FOR COMPLIANCE COULD VOID THE USERS AUTHORITY TO OPERATE THE EQUIPMENT.

WARNING: TO REDUCE THE RISK OF ELECTRIC SHOCK, DO NOT EXPOSE THIS EQUIPMENT TO RAIN OR WATER.

Instructions for Disposal of Electrical and Electronic Equipment in Private Households



Disposal of used Electrical and Electronic Equipment

(Applicable in the European Union and other European countries with garbage separate disposal and collection methods)

This symbol on the product, or in the related documents in the package, indicates that this product shall not be treated as normal household waste. Instead, it should be taken to a proper applicable collection point or depot for the recycling of electrical and electronic equipment.

By ensuring this product is disposed of correctly, you will help prevent possible negative consequences for the environment and human health, which could otherwise be caused by inappropriate waste handling of this product. The recycling of materials will help to conserve natural resources.

For more detailed information about recycling of this product, please contact your local city authority, your household waste disposal service or the place where you purchased the product.



This mark is a symbol of an operator to advise the annex.

"WARNING : To avoid the risk of electric shock, this equipment must only be connected to a supply mains with protective earth.

When it is installed, please contact the dealer or salesman.

Do not place the equipment in the way of difficult disconnecting the power plug

When before and after each use, dirt can be seen

Equipment connected to this unit that conform to IEC standards that apply to the equipment or IEC60601-1

If you are connecting to a device that is in contact with the patient to make the connection in accordance with IEC60601-1:2005 Annex I Table I.1
While connected, it is necessary to fit the evaluation and IEC60601-1:2005 Section 16.
And it's limited to the equipment with which 3 pin AC cord with FG can be connected.

Recommended for backup device preparation.

Caution : Considering the case of failure of the monitor, in the case of safety-related applications or applications requiring urgent and reliable image display, use multiple monitors at the time of use or prepare alternative machines We strongly recommend.

급 기기 업무용 방송통신기자재
이 기기는 업무용 급 전자파적합기기로서 판매자
1 또는 사용자는 이 점을 주의하시기 바라며 가정외의
지역에서 사용하는 것을 목적으로 합니다

警告

此为 A 级产品。在生活环境中，该产品可能会造成无线电干扰。
在这种情况下，可能需要用户对干扰采取切实可行的措施。



Warning:

This is a class A product. In a domestic environment this product may cause radio interference in which case the user may be required to take adequate measures.

产品中有毒有害物质或元素的名称及含量

	有毒有害物质或元素					
		汞 (Hg)	镉 (Cd)	六价铬 (Cr (VI))	多溴联苯 (PBB)	多溴二苯醚 (PBDE)
	×	×	○	○	○	○
电源软线	○	○	○	○	○	○
台座	○	○	○	○	○	○
<p>○：表示该有毒有害物质在该部件所有均质材料中的含量均在SJ/T 11363-2006 标准规定的限量要求以下。</p> <p>×：表示该有毒有害物质至少在该部件的某一均质材料中的含量超出SJ/T 11363-2006 标准规定的限量要求。</p>						

安全警告标志的说明

	<p>●关于海拔高度的安全警告标志</p> <p>标志含意：加贴该标志的设备仅按海拔 2000m 进行安全设计与评估，因此，仅适用于在海拔 2000m 以下安全使用，在海拔 2000m 以上使用时，可能有安全隐患。</p>
	<p>●关于气候条件的安全警告标志</p> <p>标志含意：加贴该标志的设备仅按非热带气候条件进行安全设计与评估，因此，仅适用于在非热带气候条件下安全使用，在热带气候条件下使用时，可能有安全隐患。</p>

Guidance and manufacturer's declaration – electromagnetic emissions		
The Model MLW-2627C-DC is intended for use in the electromagnetic environment specified below. The customer or the user of the Model MLW-2627C-DC should assure that it is used in such an environment.		
Emissions test	Compliance	Electromagnetic
RF emissions CISPR 11	Group 1	The Model MLW-2627C-DC uses RF energy only for its internal function. Therefore, its RF emissions are very low and are not likely to cause any interference in nearby electronic equipment.
RF emissions CISPR 11	Class B	The Model MLW-2627C-DC is suitable for use in all establishments other than domestic and those directly connected to the public low-voltage power supply network that supplies buildings used for domestic purposes.
Harmonic emissions IEC61000-3-2	Class A	
Voltage fluctuations/flicker emissions IEC61000-3-3	Complies	

Immunity test	IEC 60601 test level	compliance level	Electromagnetic environment guidance
Electrostatic discharge(ESD) IEC61000-4-2	±6kV contact ±8kV air	±6kV contact ±8kV air	Floors should be wood, concrete or ceramic tile. If floors are covered with synthetic material, the relative humidity should be at least 30%.
Electrical fast transient/burst IEC61000-4-4	±2kV for power supply lines ±1kV for input/output lines	±2kV for power supply lines ±1kV for input/output lines	Main power quality should be that of a typical commercial or hospital environment.
Surge IEC61000-4-5	±1kV differential mode ±2kV common mode	±1kV differential mode ±2kV common mode	Main power quality should be that of a typical commercial or hospital environment
Voltage dips, short interruptions and voltage variations on power supply input lines. IEC61000-4-11	<5% Ut (>95% dip In Ut) for 0.5 cycle 40% Ut (60% dip In Ut) for 5 cycle 70% Ut (30% dip In Ut) for 25 cycle <5% Ut (>95% dip In Ut) for 5 cycle	<5% Ut (>95% dip In Ut) for 0.5 cycle 40% Ut (60% dip In Ut) for 5 cycle 70% Ut (30% dip In Ut) for 25 cycle <5% Ut (>95% dip In Ut) for 5 cycle	Main power quality should be that of a typical commercial or hospital environment. If the user of the Model MLW-2627C-DC requires continued operation during power mains interruptions, It is recommended that the Model MLW-2627C-DC be powered from an uninterruptible power supply or battery.
Power frequency (50/60 Hz) magnetic field IEC61000-4-8	3 A/m	3 A/m	Power frequency magnetic fields should be at characteristic of a typical location In a typical commercial or hospital environment.

NOTE Ut is the a.c.mains voltage prior to application of the test level.

Guidance and manufacturer's declaration – electromagnetic emissions

The Model MLW-2627C-DC is intended for use in the electromagnetic environment specified below. The customer or the user of the Model MLW-2627C-DC should assure that it is used in such an environment.

The Model MLW-2627C-DC is intended for use in the electromagnetic environment specified below. The customer or the user of the Model MLW-2627C-DC should assure that it is used in such an environment.

Immunity test	IEC 60601 test level	compliance level	Electromagnetic environment guidance
Conducted RF IEC61000-4-6 Radiated RF IEC61000-4-3	3 Vrms 150 kHz to 80 MHz 3 V/m 80 MHz to 2.5 GHz	3 Vrms 3 V/m	Portable and mobile RF communications should be used no closer to any part of the Model MLW-2627C-DC , including cables, than the recommended separation distance calculated from the equation applicable to the frequency of the transmitter. Recommended separation distance $d=1.2\sqrt{P}$ $d=1.2\sqrt{P}$ 80~800 MHz $d=1.2\sqrt{P}$ 800 MHz~2.5 GHz where P is the maximum output power rating of the transmitter in watts (W) according to the transmitter manufacturer and d is the recommended separation distance in meters(m) Field strengths from fixed RF transmitters, as determined by an electromagnetic site survey, should be less than the compliance level in each frequency range*b. Interference may occur in the vicinity of equipment marked with the following symbol: 

NOTE 1 At 80 MHz and 800 MHz, the higher frequency range apply.

NOTE 2 These guidelines may not apply in all situations. Electromagnetic propagation is affected by absorption and reflection from structures, objects and people.

*a Field strengths from fixed transmitters, such as base stations for radio (cellular/cordless) telephones and land mobile radios, amateur radio, AM and FM radio broadcast and TV broadcast cannot be predicted theoretically with accuracy. To assess the electromagnetic environment due to fixed RF transmitters, an electromagnetic site survey should be considered. If the measured field strength in the location in which the Model MLW-2627C-DC is used exceeds the applicable RF compliance level above, the Model MLW-2627C-DC should be observed to verify normal operation. If abnormal performance is observed, additional measures may be necessary, such as reorienting or relocating the Model MLW-2627C-DC

*b Over the frequency range 150 kHz to 80 MHz, field strengths should be less than 3 V/m.

IMPORTANT SAFETY INSTRUCTIONS

1. General

- 1) Read all instructions provided.
- 2) Save these instructions for future use.
- 3) Follow all warnings and instructions marked on the monitor equipment.
- 4) Never insert objects of any kind into this monitor through cabinet slots as they may come in contact with dangerous voltage points or short out parts, resulting in fire or electrical hazards, Never spill liquid of any kind on the monitor.
- 5) Do not attempt to service this monitor yourself as operating or removing covers may expose you to a dangerous voltage or other hazards, Refer all servicing to qualified service personnel.
- 6) Do not use attachments not recommended by the monitor equipment manufacturer as they may result in the risk of fire, electric shock, or injury to persons.
- 7) This monitor has been pre-adjusted to meet the respective standard signals. So, it cannot be used with the signals of different standards.
- 8) When keeping or transporting the unit for a long time, pack it in the supplied carton or equivalent.

2. Power supply

- 1) This monitor equipment should be operated only from the type of power source indicated on the marking label.
- 2) This monitor equipment is provided with a three-wire grounding type plug with a third (grounding) pin. This plug will only fit into a grounding-type power outlet. This is a safety feature. If you are unable to insert the plug into the outlet, contact your electrician to replace either the plug or your obsolete outlet. Do not defeat the safety purpose of the grounding-type plug.
- 3) When connecting and disconnecting the power cable, be sure to hold the plug.
- 4) Do not allow anything to rest on the power cord. Do not place this monitor equipment where the cord will be abused by persons walking on it.
- 5) For added protection for this monitor equipment during a lightning storm, or when it is left unattended and unused for long periods of time, unplug it from the wall outlet. This will prevent damage to the equipment due to lightning and power -line surges.
- 6) Do not overload wall outlets and extension cords as this can result in fire or electric shock.

3. Usage and location

- 1) Do not use this Color LCD Display equipment near water - for example, near a bath tub, kitchen sink, or laundry tub, in a wet basement, or near a swimming pool, or the like.
- 2) Do not place this Color LCD Display equipment on an unstable cart, stand, or table. The Color LCD Display equipment may fall, causing serious injury to children and adults, and serious damage to the equipment. Use only with a cart or stand recommended by the manufacture, or sold with the Color LCD Display equipment. Wall or shelf mounting should follow the manufacture's instructions, and should use a mounting kit approved by the manufacture. Color LCD Display equipment and cart combination should be moved with care. Quick stops, excessive force, and uneven surfaces may cause the equipment and cart combination to overturn.
- 3) Slots and openings in the cabinet and the back or bottom are provided for ventilation, and to ensure reliable operation of the monitor and to protect it from overheating, these openings should never be blocked or covered. The openings should never be blocked by placing the Color LCD Display equipment on a bed, sofa, rug, or other similar surface. (This Color LCD Display equipment should never be placed near or over a radiator or heat register.) This Color LCD Display equipment monitor should not be placed in a built-in installation such as a bookcase unless proper ventilation is provided.
- 4) Avoid operating or placing (keeping) in a hot (+35°C or over) or cold (less than +5°C), high vibration, or dusty place. Avoid operating or storing in a place exposed to direct sunlight.
- 5) If an image of extremely high brightness is displayed on the screen for a long time, the panel may get burned in.
- 6) The installation method which does not use a stand.
 - Pan : Right & Left=0°
 - Tilt : Down $\leq 5^\circ$, Up $\leq 15^\circ$
 - Condition of around : It separates from the wall etc. by 10cm or more.
 - Use the metal fittings which suited the VESA standard.



4. Cleaning

- 1) Unplug this Color LCD Display equipment from the wall outlet before cleaning. Do not use liquid cleaners or aerosol cleaners. Use a damp cloth for cleaning.
- 2) Do not use thinners or petroleum products for cleaning. Otherwise, the cabinet may deform or the paint may peel away .

5. Repair

- 1) Unplug this Color LCD Display monitor from the wall outlet and refer servicing to qualified service personnel under the following conditions:
 - a. When the power cord or plug is damaged or frayed.
 - b. If liquid has been spilled into the Color LCD Display.
 - c. If the Color LCD Display monitor has been exposed to rain or water.
 - d. If the Color LCD Display does not operate normally by following the operating instructions. Adjust only those controls that are covered by the operating instructions as improper adjustment of other controls may result in damage and will often require extensive work by a qualified technician to restore the Color LCD Display monitor to normal operation.
 - e. If the Color LCD Display monitor has been dropped or the cabinet has been damaged.
 - f. When the monitor exhibits a distinct change in performance - this indicates a need for service.
- 2) When replacement parts are required, be sure the service technician has used replacement parts specified by the manufacturer that have the same characteristics as the original parts. Unauthorized substitutions may result in fire, electric shock, or injury to persons.
- 3) Upon completion of any service or repairs to this monitor, ask the service technician to perform routine safety checks to determine that the Color LCD Display is in safe operating condition.
- 4) For repair service, contact Ikegami's authorized sales representative or Ikegami service desk directly.

OPERATING PRECAUTIONS

- 1) Never let this unit fall or subject it to strong shock.
- 2) Do not remove the cabinet unless necessary. High-voltage parts are contained in the cabinet and they are very dangerous if you touch them. Only qualified service engineers are allowed to adjust the internal parts of the cabinet.
- 3) This color monitor has been adjusted to signals conforming to each broadcasting standard. It cannot be used for signals of different broadcasting standards. Be sure to operate the colour monitor within the voltage range marked on its back.
- 4) If cabinet or screen is dirty, wipe with soft cloth. At this time, avoid using petroleum based products or thinner, otherwise the paint may peel away.
- 5) Note that, if video signals with high luminance are monitored on the LCD panel over a long period of time, the panel may burn in the image.
- 6) Avoid using or storing this unit in the following places:
 - Hot (+35°C or more) or cold (+5°C or less) places, especially where this unit may be exposed to the direct rays of the sun.
 - Humid and dusty places.
 - Places where there is considerable vibration.
 - Places exposed to rain or water.
 - When storing or transporting this unit, pack it in the supplied carton or equivalent.
- 7) If no image can be monitored even after performing user adjustment or the unit appears faulty, do not dismantle this unit by yourself. In such cases, contact the Ikegami service desk.
- 8) Should this unit fail within one year after delivery, it will be repaired free of charge unless the malfunction was caused by mishandling or misuse of the user. However, the fuses are not covered by the warranty.
- 9) The specifications and appearance of this unit may be subject to change for further improvement without prior notice.

Contents

1. Precautions.....	1
2. General Description	4
2.1 Features	4
2.2 About Input Signals.....	4
2.3 Functions.....	5
3. Names of Parts.....	6
3.1 Names of Parts and Their Functions.....	6
4. Remote Connection	8
4.1 RS-232C terminal.....	8
4.2 USB terminal.....	8
5. Operation.....	9
5.1 Front Key Operation.....	9
5.2 Display with a Signal Being Selected.....	9
5.3 Settings and Key Operation	10
6. Configuration	11
6.1 Operation screen	11
6.2 Video Settings screen	11
6.3 Color Settings screen.....	12
6.4 Picture Settings screen	13
6.5 Input Settings screen.....	14
6.6 Setup selection screen.....	15
6.7 Input Sel. selection screen.....	16
6.8 Window Sel. selection screen.....	16
6.9 Function selection screen	17
7. Applicable Signals.....	18
7.1 Video Signals	18
7.2 Analog RGB(D-SUB),DVI(DVI-D) Computer Signals.....	18
8. Troubleshooting.....	19
9. Specifications.....	21
9.1 Specifications.....	21
9.2 Appearance view.....	22
10. Use the stand	23

1. Precautions

- When you open the cardboard box of the LCD monitor, please check that the indicated accessories and cables are present.
It is recommended not to dispose of the packaging materials and to store them for later use if it becomes necessary to transport again for after-sales service, or maintenance purposes.
- Do not install this LCD monitor in a water-splashed or highly humid environment.
- Do not use the LCD monitor where the ambient temperature drops below +5°C or Rises above +35°C. The images and component parts may be adversely affected or the monitor may not function correctly.
- Do not open the case of the monitor body, unless it is absolutely necessary for setup or installation because there are precision electrical and electronic components inside and an accident may result.
- Do not put anything metallic or other foreign substances into the body, as a fire or electric shock may result.
- Be sure to turn off the power before installing or making connections.
- Do not install the monitor in places exposed to heat, vibrations and shocks.
- Be careful not to drop or give a strong shock to this monitor while transporting it.
- It is not recommended to touch the surface of LCD panel.
- Please ensure that this device and other devices dose not produce improper operation by the electromagnetic or other interference.
- The operator must not come in contact with an outside connection connector with a patient at the same time.
- The attachment for wall hangings, use an appliance enduring the weight of the monitor.
- * Because of the digital image device characteristics, images may look unnatural at high temperatures, this does not mean the monitor is faulty.
- Don't install equipment in the place which a power plug can't be inserted and removed.
- Do not use other than the specified AC adapter and power cord.

1. Precautions

Warning on power connection.

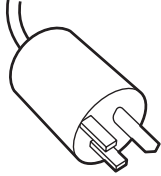
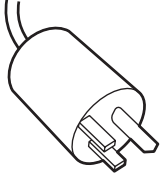
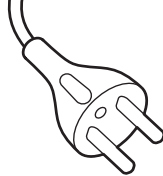





	The United States	Canada	Continental Europe
Plug Type	NEMA 5-15P HOSPITAL GRADE	NEMA 5-15P HOSPITAL GRADE	CEE7 EURO
Rated Voltage & Current	10A/125V	10A/125V	10A/250V
Safety Approval	UL	CSA	VDE
Plug Configuration			
Power Cord	Type SJT	Type SJT	H05VV-F

Use a proper power cord for your local power supply.

Requested from external connected equipment.

All the equipment connected to this unit shall be certified according to Standard IEC60601-1 applicable to the equipment.

Symbols on the unit

Symbol	Location	This symbol Indicates
	Front	Brightness Control
	Front	Contrast Control
	Bottom	Potential Equalization Terminal This symbol appears next to the display's Potential Equalization Conductor. (grand post)
	Switching power supply	Alternate current
	Switching power supply	Direct current
	Rear	Symbol “  ” This mark is a symbol of an operator to advise the annex.

Maintenance

- Clean the cabinet, panel and controls with a soft cloth lightly moistened with a mild detergent solution. Do not use any type of abrasive pad, scouring powder or solvent, such as benzene.
- Do not rub, touch, or tap the surface of the screen with sharp or abrasive items such as a ball-point pen or screwdriver. This type of contact may result in a scratched picture panel.
- Clean the screen with a soft cloth, If you use a glass cleaning liquid. Do not use any type of cleaner containing an anti static solution or similar additive as this may scratch the screen's coating.

Carrying Precautions

When you carry a Color LCD Display with optional stand (TS-300), keep a LCD display vertically during the transportation.

Please refer to Appearance view, with optional stand type illustrated in 8. Specifications. The Color LCD Display equipment may fall, causing serious injury to children and adults, and serious damage to the equipment.

Powering On The Unit

Connect the power supply to the DC input via the power plug. Plug in the AC adapter. Connect the video source to the display. The IKEGAMI logo is displayed, followed shortly by video.

The power supply interception method

Unplug a AC power cord.

Concerning handling of EN60601-1-2 (EMI) class B

This device requires installation of the following cores:

When SDI signal is input: Attach the supplied SFT-36SN(×2) to the connector base section(input,output).

When Video signal is input: Attach the supplied SFT-36SN(×2) to the connector base section(input,output).

When +5V is connection: Attach the supplied SFT-36SN and SFT-59SN(2T) to the connector base section.

AC Power cord: Attach the suppliedSFT-59SN to the connector base section.

DC Power Cable: Attach the suppliedSFT-59SN to the connector base section.

2. General Description

2.1 Features

- High-resolution image display
A full high-definition panel with a resolution of 1920(H) x 1080(V) dots is employed for displaying extremely fine images.
- Higher brightness and wider view angle
The view angle is as wide as 178° from all directions. No matter where the monitor is set up, images can be comfortably viewed from different angles.
- Less afterimages
The LCD panel has a higher response speed, which reproduces images with less afterimages.
- 10-bit signal processing
Input signals are processed to 10-bit signals, enabling smoother gradation.
- Jaggy-less I/P conversion (Interlaced-to-Progressive conversion)
The unit is equipped with a jaggy-less I/P converter in order to convert NTSC, PAL and HD interface signals to natural-looking images with unnoticeable jagged lines.
- Compatible with various types of signals
HDTV (1080P, 1080i, 720P), SDTV (NTSC, PAL), PC inputs (analog and digital), SD-SDI and HD-SDI .
- User-preset memory
The white balance, hue, and chroma values, etc. can be registered in the memory for retrieval by the user to provide eight different types of settings.
- Meeting many safety standards
The medical-use monitor conforms to US UL60601-1 and Canadian CSA22.2 No. 601.1 (cUL) safety standards too.
- MLW-2627C-DC is a monitor intended for use in a medical environment to display pictures from cameras or other system.

2.2 About Input Signals

- NTSC/PAL inputs (BNC and S terminal inputs)
The unit handles NTSC and PAL composite video signals, as well as S-Video signals, which are automatically identified to be displayed.
- RGB and component signal inputs (HD15)
Various types of signals - 480i, 575i, 480P, 576P, 1080P, 1080i and 720P, for instance - can be readily handled for images.
- Analog RGB (HD15) and DVI(DVI-D) signal inputs
Signals - VGA, SVGA, XGA, SXGA, WUXGA, 480i, 575i, 1080P, 1080i and 720P - can also be readily accepted for images. DVI supports only DVI-D.
- Input of external sync signals
The unit can get in sync with external signals such as from cameras and sync signal generators.
- SDI signals
The monitor is standard equipped with an SDI unit to get images from SD-SDI (480i, 575i) and HD-SDI (1080P, 1080i, 720P) digital signals.

2.3 Functions

- Color temperature switching function
The color temperatures can be chosen from 6500K, 9300K and user settings to select a color rendering to your taste.
- Gamma level switching function
The gamma level can be selected, compatible with DICOM14, from 1.8 to 2.6 (in 0.2 increments),
- Aspect ratio switching function
The display aspect ratio of video signals can be switched to either the 4:3 or 16:9 view angle size.
- User setting memory switching function
Colors, brightness and other image quality-related settings are user-adjustable for eight different groups. They are readily switchable.
- Input signal selection function
Input signals can be selected from input Video, S-Video, analog RGB (HD15), and DVI(DVI-D)signals.
- Power management function
When no input signal is supplied for approximately 3 minutes, automatically the energy saving mode is enabled.
- External remote control function
An externally connected device may be used to select input signals and to make various settings.
- Options
 - Stand (Model TS-300)
The optional stand is available to place the monitor for desktop use.

3. Names of Parts

3.1 Names of Parts and Their Functions

Front

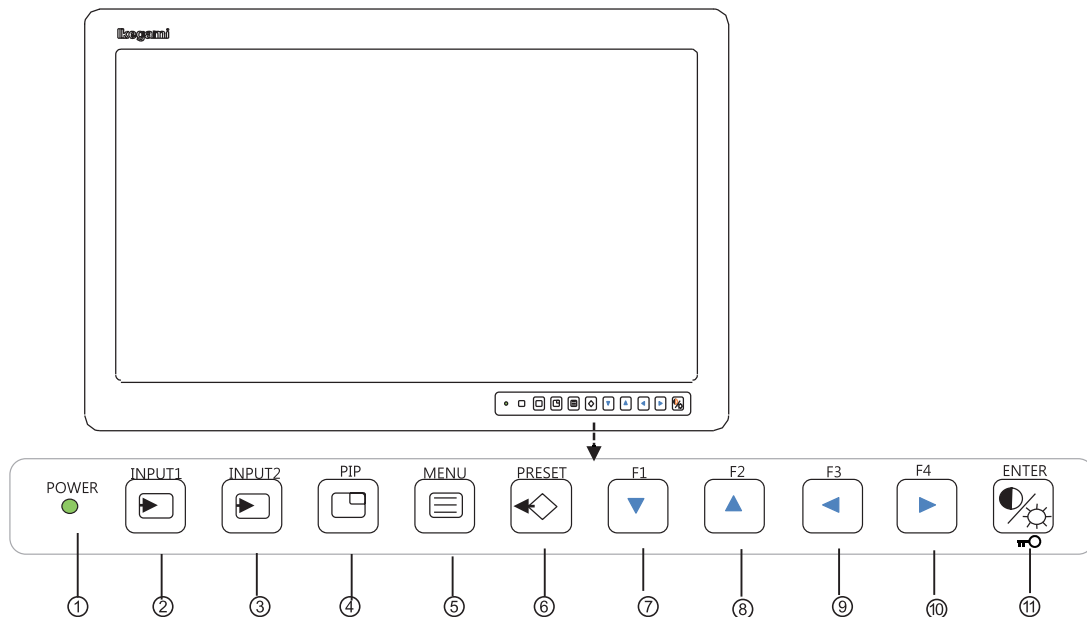

- ① Power indicator : When the power is in "ON" mode ----- Illuminate in Green
 When the power is in "OFF" mode ----- Extinction
 When the power is in "Energy saving" mode ---- Illuminate in orange
- ② Input key 1 : It will select the input signal.
- ③ Input key 2 : It will select the input signal.
- ④ PIP key : It makes the two-screen display.
- ⑤ MENU key : It will display the main menu.
 The main menu will disappear when pressed again.
- ⑥ PRESET key : It will display the preset menu.
- ⑦ F1/ ▼ key : Executes the function allocated to FUNCTION1. /It is used for selection of items and adjustment.
- ⑧ F2/ ▲ key : Executes the function allocated to FUNCTION2. /It is used for selection of items and adjustment.
- ⑨ F3/ ◀ key : Executes the function allocated to FUNCTION3. /It is used for selection of items and adjustment.
- ⑩ F4/ ▶ key : Executes the function allocated to FUNCTION4. /It is used for selection of items and adjustment.
- ⑪ ☀/⚙/ENTER : It will display contrast, brightness, the menu of./Saves the items on the Menu screen and ends the Menu screen.
 Do the lock / release of the key .

Rear

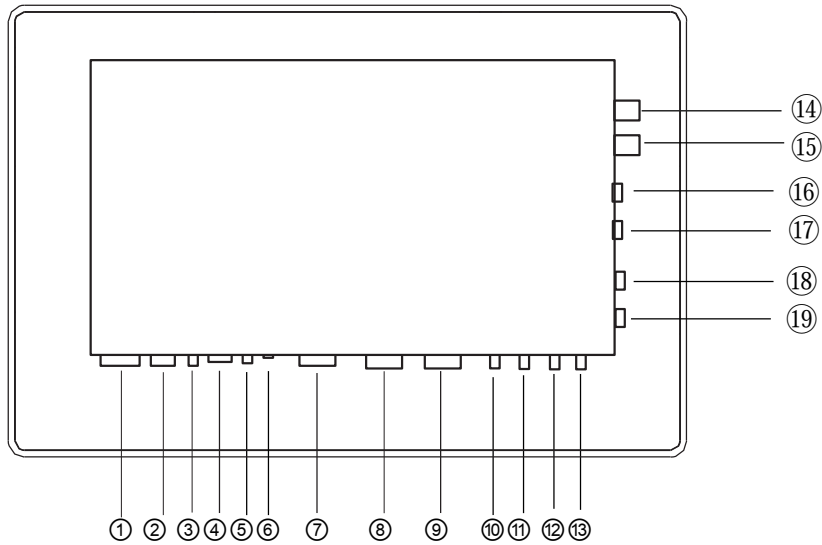

- ① Power switch : The power to "on", "off".
 - ② DC input socket : Connect the AC cord.
 - ③ Potential equalization terminal : Terminal to equalize the potentials of devices.
 - ④ RS-232C terminal : Connected to the PC, and control the machine.
 - ⑤ DC output terminal : DC5V / 1A is available.
 - ⑥ USB terminal : This is an update for the terminal of this unit.
 - ⑦ DVI-2 output terminal : Throughout terminal of the signal that is input to DVI-2.
 - ⑧ DVI-2 input terminal : Conect the DVI-D signal.
 - ⑨ DVI-1 input terminal : Conect the DVI-D signal.
 - ⑩ SDI-2 output terminal : Throughout terminal of the signal that is input to SDI-2.
 - ⑪ SDI-2 input terminal : Input terminal of the SDI signal.
 - ⑫ SDI-1 output terminal : Throughout terminal of the signal that is input to SDI-1.
 - ⑬ SDI-1 input terminal : Input terminal of the SDI signal.
 - ⑭ Video input terminal : Input terminal of the Video signal.
 - ⑮ Video signal output terminal : Throughout terminal of the signal that is input to Video.
 - ⑯ S-Video input terminal : Input terminal of the S-Video signal.
 - ⑰ S-Video output terminal : Throughout terminal of the signal that is input to S-Video.
- When the power is off, the terminal off function does not work.
- ⑱ HD15 input terminal : Input terminal of PC and video signal of analog RGB/YPbPr.
 - ⑲ HD15 output terminal : Throughout terminal of the signal that is input to HD15.

Caution1:Through out of SDI and HD15 will work only when the power is ON.
 Caution2:The capacity of 5 VDC output is 1.0A or lower, and the connection is as follows.



4. Remote Connection

4.1 RS-232C terminal

Remote control is possible with a remote control signal feed.

D-SUB 9 pin connector on LCD Monitor back

External PC/D-SUB 9 pin Connector

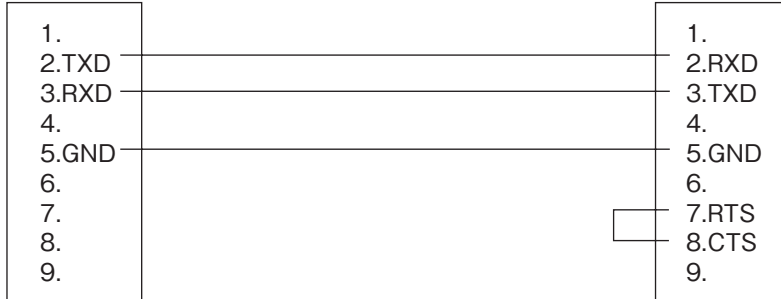

Do not connect anything to pins 1, 4, 6, 7, 8, or 9 on the monitor side (or else, a malfunction of the monitor may occur).

Note: At the PC, Pins 7 and 8 must be loop-connected.

Be sure to use a shielded cable for a remote signal cable. Please contact the sales agent where you purchased the product for details.

4.2 USB terminal

It is used for updating the monitor control software.

CAUTION!

Please do not connect external device for maintenance. It may cause the faults or mis-operation of the equipment.

5. Operation

5.1 Front Key Operation

There are ten front keys as shown below.

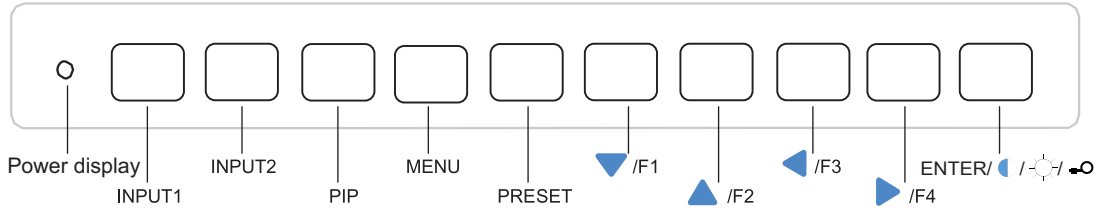

The keys have the following functions.

- INPUT1 : Switching of the input signal set to IN1. Switch to each press of the key.
- INPUT2 : Switching of the input signal set to IN2 Switch to each press of the key.
- PIP : Display switching of Picture in Picture.
- MENU : Used to display the menu.
- PRESET : Call of user presets
- ▼/F1 : Call of Choose Setup menu, Adjustment and User Function.
- ▲/F2 : Call of Choose Setup menu, Adjustment and User Function.
- ◀/F3 : Call of Choose Setup menu, Adjustment and User Function.
- ▶/F4 : Call of Choose Setup menu, Adjustment and User Function.
- ENTER / [Sun] / [Lock] : Used to put the contrast, brightness and other settings in memory, to exit and do the lock / release of the key.

If no operation is made within the OSD User Time Out setting, the pre-adjusted settings are resumed and the OSD disappears.

5.2 Display with a Signal Being Selected

5.2.1 Input Signal Screen Display

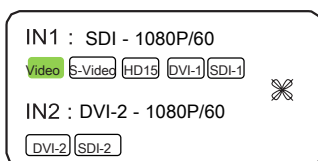

IN1: "Input" "Signal"

Signal input specified to IN1

When no input signal is set: INx : -

Fan indication ✖ : Abnormality: Stop using the unit and contact the sales agent.

5.2.2 Input Display

- SDI-1/SDI-1 : "SDI-1", "SDI-2"
- HD15 : "HD15"
- DVI-1/DVI-2 : "DVI-1", "DVI-2"
- VIDEO : "Video"
- S-VIDEO : "S-Video"

5.2.3 Signal Name Display

- SD Video line : 480i, 575i
- HD Video line : 720P/50, 720P/60, 1080i/50, 1080i/60, 1080P/50, 1080P/60
(59.94 Hz is expressed as 60 Hz.)

5. Operation

HD15 line : VGA, SVGA, XGA, SXGA, WUXGA, 480i, 575i,
720P/50, 720P/60, 1080i/50, 1080i/60, 1080P/50,
DVI line 1080P/60 : VGA, SVGA, XGA, SXGA, WUXGA, 480i, 575i,
720P/50, 720P/60, 1080i/50, 1080i/60, 1080P/50, 1080P/60

With no signal being input : No Sync

5.3 Settings and Key Operation

The setting is applied to the selected input signal.

5.3.1 OSD menu operation

Pressing the MENU button opens the screen described in Item 6. Select a tab by using the "▼ ▲" key. Move between items by using the "▶" key, and select an item by using the "▼ ▲" key, and finally adjust the value by using the "◀ ▶" key.

Each adjusted value is stored by pressing the Enter key. The screen ends when the MENU key is pressed.

5.3.2 Setting and adjustment of Direct Contrast , Brightness and User Memory

1) Contrast, Brightness

Pressing the " ENTER/ ◀ /-⊕- /⊖ " key once enables adjustments of contrast and brightness of the Main screen. The contrast can be adjusted by using the "▼ ▲" key, and the brightness can be adjusted by using the "◀ ▶" key. Pressing the " ENTER/ ◀ /-⊕- /⊖ " key again stores the current setting and ends the adjustment function.

2) User Memory

Pressing the "PRESET" key displays the setting value. Set the value by using the "◀ ▶" key. Eight types of settings from 1 to 8 are available. Pressing the " ENTER/ ◀ /-⊕- /⊖ " key stores the setting and ends the setting function.

5.3.3 Input signal selection

Pressing the INPUT1 key and the INPUT2 key switches the input signal. Pressing the key once displays the current input signal. Pressing the key again within five seconds switches the input signal. The input signal selected lastly before the power is turned off remains when the power is re-turned on for the next time.

Input signals can be set to INPUT1 and INPUT2 on the Memory select screen.

CAUTION!

To maintain the original performance of touch sensors on this monitor, please use the power cable with earth. The touch sensors may be less-sensitive with no earth cable.

Touch sensor operation touching with metal (table etc) may also be the less-sensitive.

The MENU description from following pages show all the setting on each MENU. Some items have sequential display when actual setting is done at front key.

Ex) Items for sequential display

Gamma, Noise Reduction, Display Direction etc.

6 Configuration

6.1 Operation screen

This screen is used to display the current input signal information and the monitor settings.

Screen display

Operation	Video Format	DVI 1080p/60					
Video	Video Frequency	67.5KHz /60.0Hz					
Color	RGB/YPbPr	HD15	RGB	YPbPr			
Picture		DVI-1	RGB	YPbPr			
Mode		DVI-2	RGB	YPbPr			
Setup	User Preset	1 2 3 4 5 6 7 8					
Input	Color Temp.	User 6500 9300					
PinP	Gamma	1.8	2.0	2.2	2.4	2.6	D14
Function	Model	MLW-2627Cxxx					





Displays the input signal that is selected and/or set status.

- Video Frequency : Displays the frequency of the input signal.
- RGB/YpbPr HD15 : Displays the signal format (RGB or YpbPr) that is set to HD15.
DVI-1/2 : Displays the signal format (RGB or YpbPr) that is set to DVI.
- User Preset : Used to display the number of selected memory.
- Color Temp. : Used to display the selected color setting.
- Gamma : Used to display the selected gamma level.
- Model : The model name is indicated.

6.2 Video Settings screen

This screen is used to make the power save, backlight, OSD position and other settings.

Screen display

Operation	Contrast	50 - 	+	0 - 100	
Video	Brightness	50 - 	+	0 - 100	
Color	Backlight	20 - 	+	0 - 20	
Picture	Select	Normal High			
Mode	Sharpness	0 - 	+	0 - 63	
Setup	Noise Reduction	Off Weak Mid Strong			
Input	Video Setup	0 High			
PinP	Low Latency	Off On			
Function	DICE White	Off Middle Strong			
	DICE Black	Off Middle Strong			

Setting menu such as a video signal.

- Contrast : Used to adjust the Video signal gain.
Increase the setting to get images brighter, and decrease it to get them darker.
- Brightness : Used to adjust the signal's black level offset.
Increase the setting to get images brighter, and decrease it to get them darker.





6. Configuration

- BackLight : Used to change the backlight brightness of the LCD panel.
The adjustable range is from 0 to 20.
- Select : Select function of the BackLight brightness.
"Normal" is the standard mode, and "High" is the high-intensity mode.
- Sharpness : Used to adjust the sharpness.
Increase the setting to get images shaper, and decrease it to get them softer.
- Noise Reduction : Used to reduce noises.
The noise reduction effect increases in an order of "Off," "Weak," "Middle," and "Strong."
- Video Setup : It will set up the level of the selection of video and S- video signal.
0 : Offset set tat 0%
High : Offset set at 7.5%
- Low Latency : "Slow" is the standard mode, and "Fast" is the low delay mode
- DICE Whit : Gain adjustment function for the highlight section.
- DICE Black : Gain adjustment function for the Lowlight section.

6.3 Color Settings screen

Function to adjust the display color.

Screen display

Operation	Hue	0 - 	+	±15
Video	Chroma	64 - 	+	0-128
Color	Mono	<input type="button" value="Off"/> <input type="button" value="On"/>		
Picture	Color Temp.	<input type="button" value="User"/> 6500 9300		
Mode	Gamma	1.8 2.0 <input type="button" value="2.2"/> 2.4 2.6 D14		
Setup	Color Space	<input type="button" value="BT709"/> Full		
Input	Red Gain	50 - 	+	
PinP	Green Gain	50 - 	+	
Function	Blue Gain	50 - 	+	
	HISE >>>	Hise Enable <input type="button" value="Off"/> <input type="button" value="On"/>		
		Color Select 1 2 3 4 5		
		Sharpnes Off 1 2 3 4		

- Hue : Adjusts the colors of the video.
- Chroma : Adjusts the color density of the video.
- Mono : Switches between color/monochrome. "On" is the monochrome mode.
- Color Temp. : Sets the color temperature.
6,500 degree / 9,300 degree / Native can be set. "User" is approximately 7,200 degree.
- Gamma : 1.8 to 2.6 and simplified DICOM14 are selectable.
- Color Space : BT709 and Full are selectable.
"Full" is the color range of the LCD panel without correction.
- Red Gain : Adjusts the intensity of red color in the highlight section.
- Green Gain : Adjusts the intensity of green color in the highlight section.
- Blue Gain : Adjusts the intensity of blue color in the highlight section.

· HISE : Abbreviation for Hyper Image Structure Enhancer. Adjusts specific color (different menu).

HISE Enable: To select the on/ off of HISE function.

Color Select : Select Preset 1, 2, 3, or 4 for the color adjustment as the adjustment matches the intended purpose.

Sharpness : Select Preset 1, 2, 3, or 4 for the edge adjustment as the adjustment matches the intended purpose.

6.4 Picture Settings screen

Adjustment function for display status of video signal such as a scan size.

Screen display

Operation	Display Direction	OFF	L/R	L/U	U/D	Com	
Video	Scaling	Fill	Aspect	1: 1			
Color	Scan Size	Normal	×1.05	×1.10			
Picture	H.Position	0	-			+	±200
Mode	V.Position	0	-			+	±200
Setup	H.Size	0	-			+	±200
Input	V.Size	0	-			+	0-100
PinP	Dot Clock	50	-			+	0-63
Function	Clock Phase	Auto	-			+	
	Auto Adjust	Execute					

· Display Directioin : Screen inverting function.

OFF: Standard display, L/R: Horizontally inverted display, L/ U: Vertically and horizontally inverted display, U/D: Vertically inverted display, Com: External control

· Scaling : Used to switch the video signal aspect ratio from Aspect/Fill/1:1. The switchable types depend on the type of input signal.

	Aspect	Full	1 : 1
NTSC/PAL	 1600×1080 display Black zones on both sides	 1920×1080 display Cut off at top and bottom	 720×540 display
HD	 1600x1080 display	 1920x1080 display	 1920x1080 display

when HD is input, and when Aspect and 1:1 are displayed.

· Scan Size : Used to select the display size with an overscan.

Normal : overscan OFF

×1.05 : 5% overscan

×1.10 : 10% overscan

· H/V.Position : Used to adjust the horizontal and vertical positions onscreen.

Move toward the plus side to shift the screen to top right.

Move toward the minus side to shift the screen to bottom left.

6. Configuration

- H/V.Size : Used to adjust the horizontal and vertical sizes onscreen.
Move toward the plus side to enlarge the screen.
Move toward the minus side to reduce the screen.
- Dot Clock : Adjusts the number of sampling dots of the HD15 analog signal.
The sampling frequency increases/decreases with "+" and "-" respectively. Adjust when vertical stripes and noise occur on the screen.
- Clock Phase : Adjusts the sampling point of the analog signal of PC input.
Adjust when the base section of the letters is unclear or when the noise appears when fine patterns are displayed.
- Auto Adjust : Automatically adjusts the display position and the size, the number of sampled dots, and the sampling point, depending on the input signal.

6.5 Mode Settings screen

Function to set the signal format, etc.

Screen display

Operation	RGB/YPbPr	HD15	RGB	YPbPr	
Video		DVI-1	RGB	YPbPr	
Color		DVI-2	RGB	YPbPr	
Picture	DVI-1 EQ		Auto	Low	Mid High
Mode	DVI-2 EQ		09db		14/18/21/24/26/28/30db
Setup	Fmt	Sensitivity	Fast	Slow	
Input					
PinP					
Function					

- RGB/YpbPr HD15 : Setting of signal format of HD15 input. RGB or YPbPr can be set.
DVI-1 : Setting of signal format of DVI-1 input. RGB or YPbPr can be set.
DVI-2 : Setting of signal format of DVI-2 input. RGB or YPbPr can be set.
- DVI-1 EQ : Cable correction function when a long cable is used.
"Auto" is the automatic correction. If noise remains with "Auto," remove noise by switching to "Low," "Middle," or "High."
- DVI-2 EQ : Cable correction function when a long cable is used.
Between 09 ~ 30db, please adjust so that the noise does not appear.
- Fmt Sensitivity : The signal detection operation speed can be set.
Slow: When the signal interruption is detected consecutively, the signal interruption process is conducted.
It is effective when the device is used in an environment with much noise.
Fast : After a detection of signal interruption, the signal interruption process is immediately conducted.

6.6 Setup selection screen

Function to return the user memory setting and adjustment value to the default value at the time of purchase.

Screen display

Operation	User Preset	1 2 3 4 5 6 7 8
Video	DPMS Enable	Off On
Color	Menu Position	
Picture	Menu Display	Off 10sec 30sec 60sec
Mode	Logo Display	Off 2 4 6 8 sec
Setup	Language	English Chinese
Input	Touch Beep	Off On
PinP	Long Press	Enable Disable
Function	>Reaction	Quick Normal Slow
	Front Key lock	Off On On2
	Factory Reset >>>	Reset Item Non/User/Display/Color/ALL Execute

Description of Memory Settings screen

- User Preset : Used to memorize up to eight different groups (1 to 8) of settings.
All the settings made on the menu screens can be put in memory.
- DPMS Enable : When set at ON, the display power management function puts the unit in the power-save mode if a selected input has no signal and no key is operated for longer than 3 minutes. The backlight is automatically turned off.
Power OFF/ON: To be resumed by feeding a signal or operating a key.
- Menu Position : Used to select the on-screen display position. The numerical settings allow the following display positions.
- Menu Display : Used to set the time for the on-screen display to disappear.
When the device is not operated for longer than the specified time, the OSD automatically disappears after the set time.
- Logo Display : It is possible to select the logo display when the power is turned on:
Off : No logo is displayed
2s - 8s : The display duration can be set to a time from the range from 2 seconds to 8 seconds.
- Language : Switching between English and Chinese.
- Touch Beep : Setting of beep sound when the front key is operated.
Off : No beep. On : Beep Yes.
Long Press Enable: It is worked repeatedly. Disable: It is not worked repeatedly
- >Reaction Quick、Normal、Slow
- Front key lock : Key lock function.
Off : Normal operation. On : And key lock.
Keep touching the ENTER key for longer than 3 seconds for releasing the lock.
On2 : And key lock. (When used in noisy environments, it is for malfunction prevention.).
Lock is released by touching F1, F2, F3 ,F4 and ENTER key in turn.

6. Configuration

- Factory Reset : Returns the setting to the default setting at the time of shipping from the factory.

Executes by using "Reset Item Non / User / Display /Color/All Execute".

6.7 Input selection screen

Function to allocate the signal input key.

Display screen

Operation		IN1	IN2
Video	Video	Yes	No
Color	S-Video	Yes	No
Picture	HD15	Yes	No
Input	DVI-1	Yes	No
Setup	DVI-2	No	Yes
Input	SDI-1	Yes	No
PinP	SDI-2	No	Yes
Function			

- IN1 and IN2 are provided for the input selection key. Switching the input becomes available with the key set to Yes.

6.8 PinP selection screen

Function to set the multiple display.

Display screen

Operation	Memory Number	1	2	3	4	
Video	Memory Enable	Off	On			
Color	IN1 Video Source	Video/S-Video/HD15/DVI-1/DVI-2/SDI-1/SDI-2				
Picture	IN2 Video Source	Video/S-Video/HD15/DVI-1/DVI-2/SDI-1/SDI-2				
Mode	Multi Window Mode	PinP-1/PinP-2/SbS-1/SbS-2/SbS-3/SbS-4				
Setup	Window Position					
Input	SWAP	Off	On			
PinP	PinP-1	PinP-2	SbS-1	SbS-2	SbS-3	SbS-4
Function						

- Memory Number : Specifies the preset number of the 2 screen setting.
- Memory Enable : Sets valid/invalid of the preset number.
- IN1 Video Source : Sets the input signal to be displayed on the Main screen.
- IN2 Video Source : Sets the input signal to be displayed on the Sub screen.
- Multi Window Mode : Sets the condition of the 2 screen display.
- Window Position : Sets the display position of the sub screen of IN1/IN2.
- SWAP : Function to switch the main screen and the sub screen.

Note1. When dual-screen display, there is a case where joint is generated in the sub-screen display.

Note2. In dual-screen configuration, the combination of the Video and S-Video does not work.

6.9 Function selection screen

Function to set the multiple display.

Display screen

Operation	Function 1	<input type="checkbox"/>
Video	Function 2	<input type="checkbox"/>
Color	Function 3	<input type="checkbox"/>
Picture	Function 4	<input type="checkbox"/>
Mode		
Setup		
Input		
PinP		
Function		

- Allocations of Non/Gamma/Color Temp./Disp Direction/Scaling/Hue/Chroma/Mono/Swap/HICE/Backlight/DICE White/Dice Black/Capture are possible.
Direct adjustment and setting become possible from the front function keys (F1 to F4) after the allocation.

7. Applicable Signals

7.1 Video Signals

Name	Input signal			
	Video/S-Video	SDI	HD15	DVI-D
480i/60	○	○	○ ^{*1}	○
575i/50	○	○	○ ^{*1}	○
480P/60	—	—	○	—
575P/50	—	—	○	—
1080i/60	—	○	○ ^{*1}	○
1080i/50	—	○	○ ^{*1}	○
720P/60	—	○	○	○
720P/50	—	○	○	○
1080P/60	—	○	○	○
1080P/50	—	○	○	○

*1: Only G-Sync supported,

7.2 Analog RGB(D-SUB),DVI(DVI-D) Computer Signals

Resolution	Dot clock (MHz)	Horizontal frequency (kHz)	Vertical frequency (Hz)	Horizontal sync polarity	Vertical sync polarity
640×480 60Hz	25.175	31.47	59.94	Negative	Negative
800×600 60Hz	40.00	37.88	60.32	Positive	Positive
1024×768 60Hz	65.00	48.36	60.00	Negative	Negative
1280×1024 60Hz	108.00	63.98	60.12	Positive	Positive
1920×1200 60Hz	154.00	74.0	60.0	Positive	Positive

8. Troubleshooting

No image appears on the monitor screen.

- Check to see if the AC power cord is tightly plugged in.
- Check to see if the unit's power switch is turned on.
- Check the input signal.
- Check to see if the input is selected as specified.
- Check to see if the signal is listed in the applicable signals chart.

Images on the monitor screen are improper.

- Check to see if the input is fed into the selected input terminal.
- Check to see if the video signal cable is tightly connected.
- Check to see if the signal is listed in the applicable signals chart.
- Check to see if the signal is fed to the input side, not to the output side.

Images are too dark.

- Check to see if the video signal level is as specified.
- Check to see if the brightness control is at minimum.
- Check to see if the contrast control is at minimum.
- Check to see if the backlight level on the User Setting Screen is too low.
- Check to see if the R.Gain, G.Gain or B.Gain level on the Color Setting Screen is too low.
- Check to see if the S-Video input is handled in the through-out configuration and if two or more units are connected with the main power off. The S-Video input is terminated on when the main power is turned off. Turn on the main power of all the monitors.

Highlighted images are not accentuated.

- Check to see if the input signal is connected to the IN side, not to the OUT side.
- Check to see if the contrast control is at maximum with high-level input signals.
- Check to see if the R.Gain, G.Gain or B.Gain level on the color setting is to high.

Images are too weak.

- Check to see if the chroma near the proper value of 64.
- Check to see if the brightness level is too high.
- Check to see if the gamma level is appropriately at 2.2.
- Check to see if the R.Gain, G.Gain or B.Gain level on the Color Setting Screen is too low.

Colors are not as specified.

With Video or S-Video signal inputs

- Check to see if the brightness and contrast levels are as specified.
- Check to see if the chroma and hue levels on the Image Setting Screen are as specified.
- Check to see if the color temperature is selected and preset as specified.
- Check to see if the R.Gain, G.Gain or B.Gain level on the Color Setting Screen is as specified.

8. Troubleshooting

The screen size is wrong.

- Check to see if the signal is listed in the applicable signals chart described under section 6.
- On the Display Setting screen, set the AUTO. If the desired setting cannot be obtained, adjust H.Position, V.Position, H.Size, V.Size, and Clock.
- Adjust H.Position, V.Position, H.Size, V.Size, and Clock on the Display Setting screen.

Images are dislocated.

- Check to see if the signal is listed in the applicable signals chart.
- On the Display Setting screen, set the AUTO. If the desired setting cannot be obtained, adjust H.Position, V.Position, H.Size, V.Size, and Clock.
- On the Display Setting Screen, readjust the H. Position, V.Position, H.Size, V.Size and Clock settings.

Images are distorted.

- Check to see if the external sync signal is connected with the input signal.
- Look at the Display Setting Screen to see if the Clock setting is as specified.

Vertical stripes are found.

- On the Image Setting Screen, readjust the Noise Reduction settings.
- On the Display Setting Screen, readjust the Clock and Phase settings.

Too many noises appear.

- On the Image Setting Screen, readjust the Noise Reduction settings.
- On the Display Setting Screen, readjust the Clock and Phase settings.

Input cannot be switched.

- Please make sure PinP mode is not selected.
In case it displays “Multi” at signal display menu on the upper-left, PinP mode is selected. Please switch to Single mode by pressing PinP key.

No response on touch sensor key.

- Please make sure the power cable is with ground.

Others

- When an input signal is switched to another one, the onscreen image may blink. This is not a unit failure, however.

9. Specifications

9.1 Specifications

Model		MLW-2627C-DC
LCD size		26-inch
Drive system		TFT active matrix system
Display dots		1920 (H) × 1080 (V)
Screen size		576.0 (H) × 324.0 (V) mm
View angle		Horizontal : 178°, Vertical : 178° (standard)
Contrast ratio		1400 : 1 (standard)
Display colors		1,073,741,824 colors
Video input	Video /S-Video	One line each, with loop-through (SD)
	SDI	One line, with loop-through (SD/HD)
Component input (HD15)	RGB/YPbPr	One line, with loop-through (Ext. Sync enable) (SD/HD)
	Analog/Digital	DH15 1 line ,SDI 2 line (VESA Vf=60 Hz, VGA thru WUXGA/SD/HD)
Outside dimensions		640 (W) × 405(H) × 84 (D) mm (without stand)
Unit weight		Approx. 8.0kg (without stand)
Power consumption		DC24V/3.8A
Supply voltage		DC 24V
Operating temperature range		5°C to 35°C
Operating humidity range		30-80% (no condensation)
Transport/Storage	Temperature	-20°C ~ 60°C
	Humidity	30 ~ 90% (no condensation)
	Atmospheric pressure	700 ~ 1060hPa
Accessories		Power cord, AC Adapter, Instruction Manual,
Degree of safety in the presence of flammable anesthetics or oxygen		Not suitable for use in the presence of flammable anesthetics or oxygen.
Mode of operation		Continuous
Manufacturers		Ikegami Tsushinki Co., Ltd.
Accessories supplied		AC adapter, AC power cord, Instructions for use, Ferrite core.

9.2 AC Adapter for MLW-2627C-DC

Model		HPU101-108
Manufacturer		SINPRO ELECTRONICS
Outside dimensions		146 (W) × 43 (H) × 76 (D) mm
Unit weight		Approx. 670 g
Protection against electric shock		Class I
AC IN		100-240 VAC 47-63 Hz 1.2-0.5 A
DC OUT		24 VDC 4.16 A Max.
Operating temperature range		5°C to 35°C
Operating humidity range		30-80% (no condensation)
Transport/Storage	Temperature	-20°C ~ 60°C
	Humidity	30 ~ 90% (no condensation)
	Atmospheric pressure	700 ~ 1060hPa

9.3 Appearance

view <without stand type>

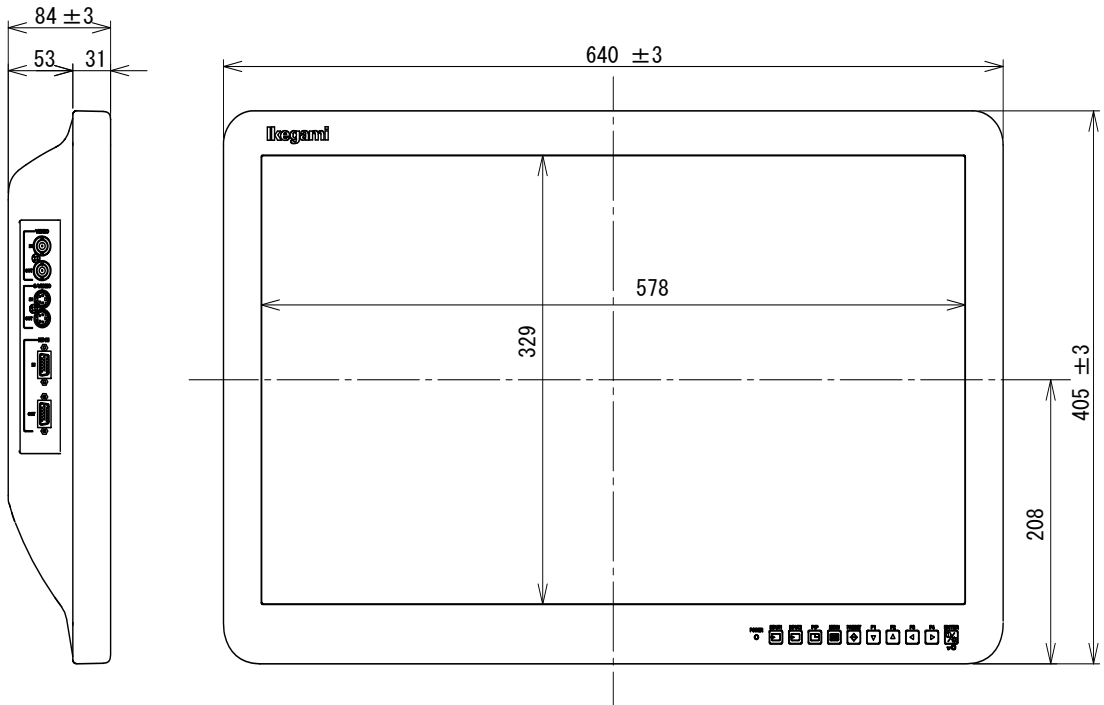

Specifications and design are subject to change for product improvements without notice.

10. Use the stand

- Clean work area.

To protect monitor screen : wipe off work area and place monitor (Screen-side down) on a soft cloth or towel before proceeding with installation.

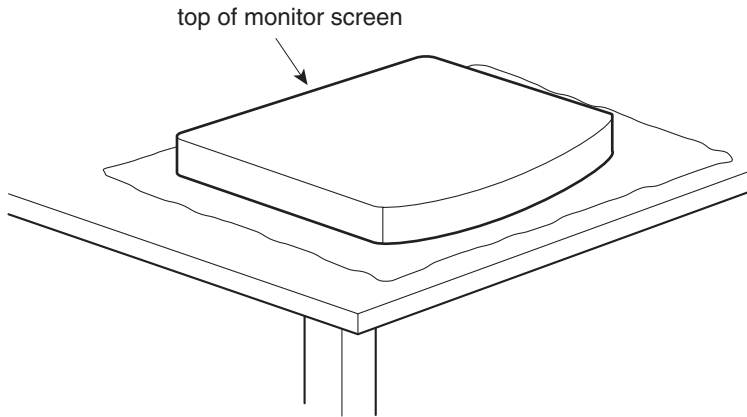

- Attach stand to monitor.

Start screws as far as possible by hand, then tighten with screwdriver.

If your monitor uses a screw size other than M4 x 8 mm, DO NOT use the M4 x 8 mm screws provided as they could result in damage to the monitor.

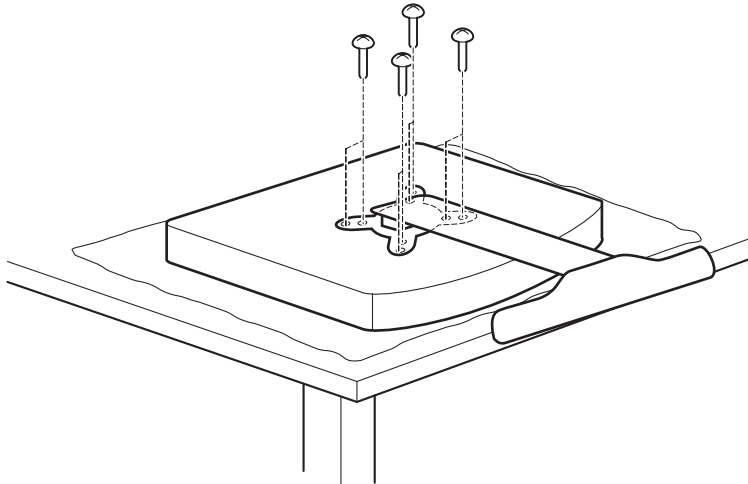

Ikegami

Ikegami Tsushinki Co., Ltd.

5-6-16, Ikegami, Ohta-ku, Tokyo, Japan 146-8567
Phone:03-5700-1111 Fax:03 -5700-1137

Ikegami Electronics (U.S.A.), Inc.

37 Brook Avenue, Maywood, New Jersey 07607
Phone:201-368-9171, Fax:201-569-1626

Ikegami Electronics (Europe) GmbH

Ikegami Strasse 1, D-41460 Neuss, Germany
Phone:02131-1230, Fax:02131-102820

Ikegami Electronics Asia Pacific Pte. Ltd.

Tampines Central 5, #03-03 CPF Tampines
Building, Singapore 529508
Phone:6260-8820, Fax:6260-8896